

■ Edition 4

## MEDIA TECHNOLOGY

**HELU**EVENT

**HELU**LIGHT

**HELU**SOUND

Data sheets are as of date of print.  
You can find the latest versions online  
according to this principle:  
[www.helukabel.com/10001en](http://www.helukabel.com/10001en)\*

\* Instead of 10001 please insert the wanted part number.



## ■ INTRODUCTION

Cables and wires designed for use in media entertainment technology put the focus not on the artists but on the stars behind the scenes. Without these unseen performers the perfect sound, amazing lighting effects, and outstanding image quality would not be possible.

This catalogue contains our entire product range for stage, film, performance and event applications. Of the new products in the fourth edition of our catalogue, I would particularly like to draw your attention to HELUEVENT®, a load cable for studio productions devised in collaboration with broadcasting company ZDF. This cable is flame retardant and halogen free, and therefore non-toxic, highly durable, coilable, and above all, abrasion resistant.

An even wider range of high-quality, coordinated cable solutions are now available from stock under our HELULIGHT®, HELUSOUND® and the brand new HELUEVENT® brand names. Finally in case you cannot find the exact cable you are looking for, our cable designers will be happy to construct the solution you need.



Helmut Luksch,  
Chief Executive Officer, HELUKABEL® GmbH



# ■ HELUKABEL® AT A GLANCE

## FAMILY FOCUSED

- Family enterprise since 1978

## QUALITY-MINDED AND ECO-FRIENDLY

- ISO 9001 & 14001
- Energy supplied by the firm's own solar and bio-gas plant

## SUCCESSFUL

- 430 million Euro turnover
- 1000 employees

## GLOBAL

- 41 locations in 24 countries

## PRODUCTION

- 6 manufacturing and assembly locations worldwide

## LOGISTICS

- 33,000 products in stock, from the cable gland to the 2.40 m cable drum
- 24 h delivery service
- State-of-the-art logistics facility

## PRODUCTS

- Cables, wires and cable accessories
- single-source supplier for industry and infrastructure

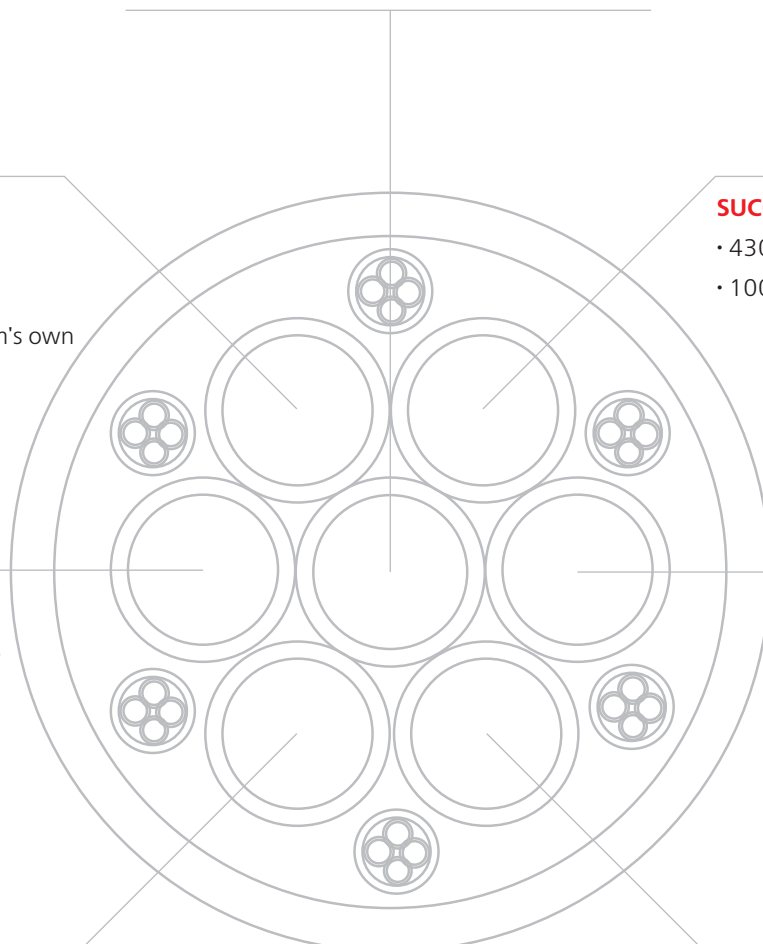

# ■ TABLE OF CONTENTS

<b>IINRODUCTION</b> .....	<b>1</b>
Research & development.....	4
Production .....	6
Logistics.....	8
Always close to you - 41 locations in 24 countries .....	10
Overview of stage technology cabling .....	12
<b>AUDIO &amp; LIGHT</b> .....	<b>14</b>
<b>VIDEO</b> .....	<b>42</b>
<b>DATA, NETWORK AND BUS TECHNOLOGY</b> .....	<b>58</b>
<b>POWER CABLES</b> .....	<b>62</b>
<b>CONNECTING CABLES</b> .....	<b>82</b>
<b>TECHNICAL INFORMATION</b> .....	<b>92</b>
Characteristics of insulating and sheath materials .....	94
AWG wires.....	96
Copper calculations.....	98
Fire performance and fire propagation .....	99
Glossary.....	100
Order form .....	104
Part No. index .....	105
Notes.....	106



We are member of: Licht-, Ton- und Veranstaltungstechnik





## ■ RESEARCH & DEVELOPMENT

We develop optimal, tailored cable solutions for our customers.



Torsion test apparatus

### Our test facilities:

- Test systems for bending and torsion requirements
- Drag chain test systems with movement distances of 1 m, 3 m, 5 m, 6 m, 18 m, and 40 m
- Fire testing systems
- Abrasion testing systems
- Torsion test tower for wind turbine cables
- Aging ovens in accordance with UL, VDE, CSA, HAR, TÜV & CCC

Research and development are the foundation of our work and are an important engine for growth. In interdisciplinary teams we continuously push the boundaries to enhance our products and develop solutions to meet the latest technological demands. Moreover, we value our customer interactions and partnerships with regional colleges and research institutes to stay on top of emerging technologies.

The materials that we use are an important starting point of our work. In this regard, we place as much emphasis on searching for and utilizing new materials, as we do on manufacturing our plastic mixtures (granulates) ourselves, and influencing the improvement of technical characteristics, such as oil-resistance, temperature range or chemical compatibility. Moreover, we are capable of pulling a majority of the copper ourselves, thus ensuring a uniform,

high-quality product relative to properties and workmanship.

With continuous optimization of our manufacturing processes and systems we take into consideration both efficient and economical production, and the complex requirements of various applications (such as cables for industrial robots or for applications under cleanroom conditions) into account.

A crucial stage in the development process of our products is the work done at our Test Center. For example, cables suitable for drag chain implementation, can be tested using equipment that accelerates cables up to 10 g.

Temperature ranges from  $-50^{\circ}$  to  $+250^{\circ}$  are simulated in a special climate-controlled environment so that drag chain cables can be tested for series production readiness in applications such as refrigerated warehouses or steel mills.



Drag chain test system







## ■ PRODUCTION

We specialize in the production of high-quality cables and wires.

Using the latest production methods, our two German plants manufacture approximately one million kilometers of conductors each year (= 77 times around the world). More than 300 qualified employees are specialized in the production of high-quality standard and custom cables. Through the use of the latest materials and collaboration with international test institutes, we drive innovation in the areas of automation, data technology, building system technology, and renewable energy.

Since 2014, in a 7,000 m<sup>2</sup> facility in the Chinese city of Taicang (approx. 50 km northwest of Shanghai) HELUKABEL® has been producing cable and wires, primarily for the Asian market. As is with our German plants, the focus is on high-quality, flexible and highly-flexible cables and wires that are manufactured in accordance with Chinese and international standards. The use of flexible manufacturing cells enable short delivery times.



Braiding machine



Stranding machine

Our production in numbers:

- 40,000 m<sup>2</sup> production area
- 23 extruder systems
- 19 stranding machines
- 50 braiding machines
- Cables & wires from 0.05 to 1,000 mm<sup>2</sup> (30 AWG to 2,000 kcmil)
- Manufacturing in accordance with: VDE, EAC (GOST-R), UL, CSA, HAR, CCC, Germanischer Lloyd, TÜV or customer specification







## ■ LOGISTICS

Redefining logistics in the cable industry.

### INDUSTRIAL CABLE

#### Our logistics center – Hemmingen/Stuttgart

- 40,500 Euro-pallet racks
- 16 aisles with 16 storage and retrieval devices
- 35,900 bin locations in the automatic small parts warehouse with a capacity of 1,000 bins per hour
- 670 storage spaces in the heavy load warehouse with max. reels of 4,000 kg and 2.20 m diameter
- 2 km conveyor line for pallets
- Conveyor connects direct to the cable-cutting machines
- Manual processes reduced to merely packing

### INFRASTRUCTURE CABLES

#### Our logistics center – Neuenhagen/Berlin

- 11,000 cable reels in stock
- Automatic processing of reels up to 2.80 m Ø and 10 t
- 10 rewinding machines
- Cut to length with state-of-the-art 1,200 mm<sup>2</sup> cutting tools
- 24-hr delivery is possible

At its corporate headquarters in the Swabian town of Hemmingen/Stuttgart, HELUKABEL® operates Europe's largest distribution center for cables and wires. Here a majority of the more than 33,000 products are located in a storage area of 160,000 m<sup>2</sup>. Through the use of state-of-the-art conveyor and control technology, more than 1,000 orders can be picked and dispatched daily to destinations around the world.

Neuenhagen/Berlin is the central warehouse location for underground, medium-voltage, and other infrastructure cables. Storage capacities of more than 5,000 m<sup>2</sup> (indoor) and 50,000 m<sup>2</sup> (outdoor) enable fast delivery of cable, configured from 1 – 30 kV, to construction sites and major projects. The patented heavy-load cable-cutting machines with a load capacity of more than 10 tons are the largest of their kind in Germany.

The new logistics center at the Taicang (Shanghai, China) production facility serves as a product distribution hub for the Asian market, and offers incredible advantages, particularly for servicing time- and volume-critical customer projects.



Heavy-load, cable-cutting facility



Small parts warehouse



# ■ ALWAYS CLOSE TO YOU - 41 LOCATIONS IN 24 COUNTRIES

## HELUKABEL® GmbH - Germany

### Headquarters

Dieselstrasse 8-12  
71282 Hemmingen / Stuttgart  
Telephone: +49 7150 9209-0  
Fax +49 7150 81786  
info@helukabel.de

### Sales office & warehouse - Berlin

Zum Mühlenfliess 1  
15366 Neuenhagen / Berlin  
Telephone +49 3342 2397-0  
Fax +49 3342 80033  
info@helukabel.de

### Sales office & warehouse - Pleiða

Eichelbergstrasse 7  
09212 Limbach-Oberfrohna  
Telephone +49 3722 6086-0  
Fax +49 3722 6086-420  
info@helukabel.de

### Sales office - North

Bahnhofstrasse 9  
25524 Itzehoe  
Telephone +49 4821 40394-0  
Fax +49 4821 40394-29  
info@helukabel.de

### Sales office - Rhein-Ruhr

Am Handwerkshof 2-4  
47269 Duisburg  
Telephone +49 203 73995-0  
Fax +49 203 73995-210  
info@helukabel.de

### Development & production

Neuseser Weg 11  
91575 Windsbach  
Telephone +49 9871 6793-0  
Fax +49 9871 1055  
info@helukabel.de

## Robotec Systems GmbH - Germany

### Head office

Carl-Friedrich-Gauß-Strasse 7  
47475 Kamp-Lintfort  
Telephone: +49 (0)2842 92148-0  
Fax: +49 (0)2842 92148-10  
www.robotec-systems.de  
info@robotec-systems.de

### Branch office - South

Willi-Bleicher-Strasse 4-6  
71282 Hemmingen  
Telephone: +49 (0)7150 9209-308  
Fax: +49 (0)7150 9209-164  
www.robotec-systems.de  
info-sued@robotec-systems.de

## Kabelmat Wickeltechnik GmbH - Germany

Steinbuckelweg 25  
72293 Glatten  
Telephone +49 7443 9670-0  
Fax +49 7443 9670-39  
kabelmat@kabelmat.com

## HELUKABEL® international locations



### HELUKABEL® Austria

Telephone +43 7224 90555 0  
Email: office@helukabel.at



### HELUKABEL® Malaysia

Telephone +603 7885 8724  
Email: sales@helukabel.com.my



### HELUKABEL® Switzerland

Telephone +41 56 4181515  
Email: contact@helukabel.ch



### HELUKABEL® Belgium

Telephone +32 24 81 00 20  
Email: info@helukabel.be



### HELUKABEL® Middle East

Telephone +971 48 87 95 94  
Email: info@helukabel.ae



### HELUKABEL® Thailand

Telephone +66 2927 3570 3  
Email: info@helukabel.co.th



### HELUKABEL® Canada

Telephone +1 289 444 5040  
Email: sales@helukabel.ca



### HELUKABEL® Netherlands

Telephone +31 495 499 049  
Email: info@helukabel.nl



### HELUKABEL® Turkey

Telephone +90 212 502 41 95  
Email: info@helukabel.com.tr



### HELUKABEL® China

Telephone +86 21 58693999  
Email: info@helukabel.com.cn



### HELUKABEL® Poland

Telephone +48 46 85 80 10 0  
Email: biuro@helukabel.pl



### HELUKABEL® UK

Telephone +44 151 345 0808  
Email: info@helukabel.co.uk



### HELUKABEL® Czech Republic

Telephone +42 0312 672 620  
Email: prodej@helukabel.cz



### HELUKABEL® Russia

Telephone +7 812 449 10 60  
Email: info@helukabel.ru



### HELUKABEL® USA

Telephone +1 847 930 5118  
Email: sales@helukabel.com



### HELUKABEL® France

Telephone +33 389 627562  
Email: info@helukabel.fr



### HELUKABEL® Singapore

Telephone +65 65 54 6170  
Email: sales@helukabel.com.sg



### HELUKABEL® India

Telephone +91 22 25 18 58 41  
Email: info@helukabel.in



### HELUKABEL® South Africa

Telephone +27 11 462 8752  
Email: info@helukabel.co.za



### HELUKABEL® Indonesia

Telephone +62 213 848872  
Email: sales@helukabel.co.id



### HELUKABEL® South Korea

Telephone +82 51 9728646  
Email: info@helukabel.co.kr



### HELUKABEL® Italy

Telephone +39 039 6081503  
Email: info@helukabel.it



### HELUKABEL® Sweden

Telephone +46 8 55 77 4280  
Email: info@helukabel.se

# OVERVIEW OF STAGE TECHNOLOGY CABLING

LIGHTING TECHNOLOGY

LED/VIDEO SCREEN



MUSICAL INSTRUMENTS/  
MICROPHONE

SPEAKER SYSTEMS



## SPEAKER SYSTEMS

Audio cables with braided screen .....	16	Digital audio cables AES/EBU, multipaired, pair and overall foil screen.....	23
Audio cables, multicore with braided screen .....	17	Digital audio cables AES/EBU, multipaired, pair and overall foil screen, halogen-free .....	24
Audio cables with foil screen, single pair .....	18	Speaker cables, twin cores .....	35
Audio cables, multipaired with foil screen .....	19	Speaker cables, round .....	36
Audio cables, multipaired, spirally screened pairs and overall braided screen .....	20	Speaker cables HELUSOUND® 500 PUR .....	37
Digital audio cables AES/EBU, single pair with spiral screen .....	21	Speaker cables HELUSOUND® 600 FRNC, halogen-free....	38
Digital audio cables AES/EBU, single pair with foil/braided screen .....	22	Speaker cables, coaxial.....	39
		Speaker cables, preassembled.....	85

## LIGHTING TECHNOLOGY

AES/EBU & DMX-cable patch.....	25	DMX-POWER.....	28
AES/EBU & DMX-cable.....	26	DMX-POWER 1 x 2 x 0,25 .....	29
AES/EBU TP DMX 512.....	27	AES/EBU / DMX 512, preassembled.....	84

## MUSICAL INSTRUMENTS/MICROPHONE

Instrument cables with spiral screen.....	30	Microphone cables with braided screen, star quads.....	33
Microphone cables with spiral screen, paired.....	31	Microphone cables with braided screen, halogen-free.....	34
Microphone cables with braided screen.....	32	Microphone cable preassembled.....	86

## LED/VIDEO SCREEN

Video cable, single core.....	44	Camera cable.....	46
Video cable, multicore.....	45	Video cable, preassembled.....	87

## MIXER/CONTROL APPARATUS POWER

Overview DNB-Cables.....	60	SiHF.....	78
Overview Power Cables.....	64	H07 V-K/ (H)07 V-K.....	80
JZ-600.....	68	HELUTEK-Star, preassembled on both sides with flexible	
JZ-600-Y-CY.....	70	JZ-500, numbered .....	90
H07 RN-F.....	72	HELUTEK-Star, preassembled on both sides with flexible	
Megaflex® 500.....	74	JZ-600, numbered .....	91
Megaflex® 500-C.....	76		



AUDIO

AUDIOKABEL AES/EBU DMX

LUSPRECHERLEITUNG

AUDIOSOUND AUDIOKABEL DIGITAL 12X2

# ■ AUDIO & LIGHT

<b>Designation</b>	<b>Page</b>
Audio cables with braided screen	16
Audio cables, multicore with braided screen	17
Audio cables with foil screen, single pair	18
Audio cables, multipaired with foil screen	19
Audio cables, multipaired, spirally screened pairs and overall braided screen	20
Digital audio cables AES/EBU, single pair with spiral screen	21
Digital audio cables AES/EBU, single pair with foil/braided screen	22
Digital audio cables AES/EBU, multipaired, pair and overall foil screen	23
Digital audio cables AES/EBU, multipaired, pair and overall foil screen, halogen-free	24
AES/EBU & DMX patch cable	25
AES/EBU & DMX cables	26
AES/EBU TP DMX 512	27
DMX-POWER	28
DMX-POWER	29
Instrument cables with spiral screen	30
Microphone cables with spiral screen, paired	31
Microphone cables with braided screen	32
Microphone cables with braided screen, star quads	33
Microphone cables with braided screen, halogen-free	34
Speaker cables, flat	35
Speaker cables, round	36
Speaker cables, round	37
Speaker cables, round, halogen-free	38
Speaker cables, coaxial	39
Load cables	40
Load cables	41



# Audio

## Audio cables with braided screen

HELUSOUND®



### Type

#### Cable structure

Conductor material:  
Core insulation:  
Core colours:  
Stranding element:  
Sheath material:  
Cable external diameter:  
Sheath colour:

#### HELUSOUND audio cable analog 2x0,25 + 0,25

Copper, bare  
PVC  
rd, wh  
2 cores with 1 filler and 1 earth conductor stranded  
PVC  
app. 3,4 mm  
black

#### Electrical data

Conductor resistance, max.: 75 Ohm/km  
Insulation resistance, min.: 5 MOhm x km

#### Technical data

Weight: app. 20 kg/km  
Min. bending radius for laying: 35 mm  
Operating temperature range min.: -25°C  
Operating temperature range max.: +70°C  
Copper weight: 13,5 kg/km

Part no.	Cable structure	Conductor resistance Ohm / km	Outer diameter app. mm	Cop. weight kg / km	Weight app. kg / km
400000	2x0,25 + 0,25	< 75,0	3,4	13,5	20,0
400001	2x0,33+0,33	< 60,0	4,0	16,3	26,0
400002	2x0,5+0,33	< 36,8	5,6	26,1	49,0

Dimensions and specifications may be changed without prior notice.

### Application

The HELUSOUND® audio cable is a 2-core, shielded multipurpose cable with earth conductor. It is particularly suitable for use in microphone, radio, studio and transmission systems.

Analog cable for short transmission distances and low frequencies.

# Audio

Audio cables, multicore, with braided screen

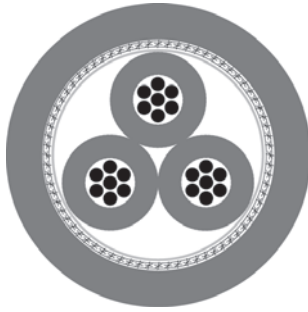

## Type

### Cable structure

Conductor material:  
Core insulation:  
Stranding element:  
Sheath material:  
Cable external diameter:  
Sheath colour:

### HELUSOUND audio cable analog

#### 2x0,26

Copper, bare  
PE  
pairs stranded  
PVC  
app. 5,2 mm  
black

### Electrical data

Conductor resistance, max.: 73,9 Ohm/km  
Insulation resistance, min.: 1 GOhm x km

### Technical data

Weight: app. 37 kg/km  
Min. bending radius for laying: 52 mm  
Operating temperature range min.: -25°C  
Operating temperature range max.: +70°C  
Copper weight: 16,8 kg/km

Part no.	Cable structure	Conductor resistance Ohm / km	Outer diameter app. mm	Cop. weight kg / km	Weight app. kg / km
400003	2x0,26	< 73,9	5,2	16,8	37,0
400004	2x0,33	< 61,6	5,3	18,2	38,0
400005	4x0,33	< 61,6	5,9	27,2	52,0
400006	2x0,50	< 39,0	5,7	22,0	46,0
400007	2x0,75	< 26,0	7,2	30,0	70,0
400008	3x0,75	< 26,0	7,7	50,0	90,0
400009	4x0,75	< 26,0	8,3	60,0	102,0
400010	5x0,75	< 26,0	8,9	72,0	120,0

Dimensions and specifications may be changed without prior notice.

## Application

The 2-5-core shielded HELUSOUND® audio cable with a common PE core insulation, braided shielding and PVC outer sheath is especially well suited for use in microphone, loudspeaker, radio and transmission systems.

# Audio

## Audio cables, single pair, with foil screen

HELUSOUND®



### Type

#### Cable structure

Conductor material:  
Core insulation:  
Core colours:  
Stranding element:  
Sheath material:  
Cable external diameter:  
Sheath colour:

### Analog audio cables

#### 2x0,22

Copper, tinned  
PE  
rd, bu  
2 cores with 1 filler  
PVC  
app. 3,4 mm  
black

### Electrical data

Conductor resistance, max.: 86 Ohm/km  
Insulation resistance, min.: 1 GOhm x km

### Technical data

Weight: app. 17 kg/km  
Min. bending radius for laying: 35 mm  
Operating temperature range min.: -25°C  
Operating temperature range max.: +70°C  
Copper weight: 6,6 kg/km

### Part no.

**400011**

Dimensions and specifications may be changed without prior notice.

### Application

The 2-core HELUSOUND® audio cable is a foil shielded cable with earth conductor. This symmetrical cable is suitable for use in racks and for studio cabling.

# Audio

Audio cables, multipaired, pairs with foil screen

**HELUSOUND**

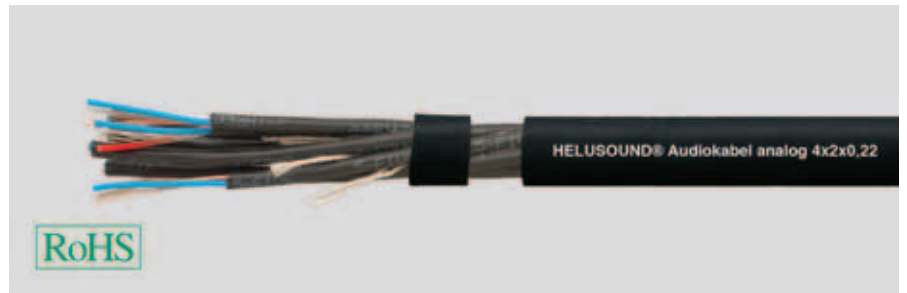

## Type

### Cable structure

Conductor material:  
Core insulation:  
Core colours:  
Stranding element:  
Sheath material:  
Cable external diameter:  
Sheath colour:

## Analog audio cables

### 2x2x0,22

Copper, tinned  
PE  
rd, bu  
pairs stranded  
PVC  
app. 7,6 mm  
black

## Electrical data

Conductor resistance, max.: 86 Ohm/km  
Insulation resistance, min.: 1 GOhm x km

## Technical data

Weight: app. 72 kg/km  
Min. bending radius for laying: 76 mm  
Operating temperature range min.: -25°C  
Operating temperature range max.: +70°C  
Copper weight: 15,0 kg/km

Part no.	Cable structure	Outer diameter app. mm	Cop. weight kg / km	Weight app. kg / km
400012	2x2x0,22	7,6	15,0	72,0
400013	4x2x0,22	9,2	29,0	100,0
400014	8x2x0,22	12,2	59,0	179,0
400015	12x2x0,22	14,2	90,0	248,0
400016	16x2x0,22	16,4	111,0	337,0
400017	20x2x0,22	18,4	149,0	421,0
400018	24x2x0,22	20,4	178,0	493,0
400019	32x2x0,22	22,4	238,0	620,0
400020	40x2x0,22	24,6	303,0	759,0

Dimensions and specifications may be changed without prior notice.

## Application

The HELUSOUND® audio cable is an insulated, multi-core audio cable which is screened symmetrically and in pairs. The cable is particularly suitable for permanent laying in public buildings, such as, e.g. theatres or music stages and for permanent studio installation.



# Audio

Audio cables, multipaired, spirally screened pairs and overall braided screen

**HELUSOUND**

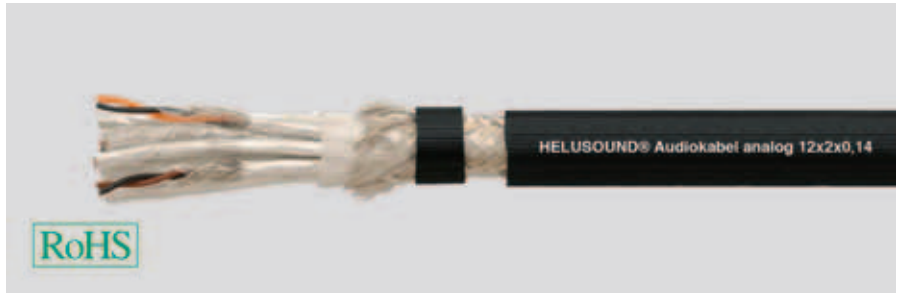
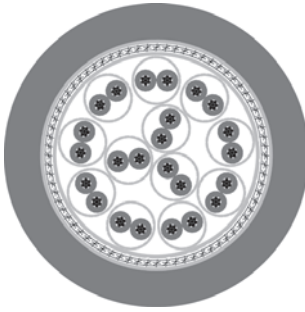

## Type

### Cable structure

Conductor material:  
Core insulation:  
Stranding element:  
Sheath material:  
Cable external diameter:  
Sheath colour:

## Analog audio cables

### 12x2x0,14

Copper, tinned  
TPE  
pairs stranded  
PUR  
app. 12,7 mm  
black

## Analog audio cables

### 16x2x0,14

Copper, tinned  
TPE  
pairs stranded  
PUR  
app. 14,1 mm  
black

## Electrical data

Conductor resistance, max.:  
Insulation resistance, min.:

150 Ohm/km  
100 MOhm x km

150 Ohm/km  
100 MOhm x km

## Technical data

Weight:  
Min. bending radius for laying:  
Operating temperature range min.:  
Operating temperature range max.:  
Copper weight:

app. 190 kg/km  
127 mm  
-25°C  
+70°C  
118,0 kg/km

app. 247 kg/km  
142 mm  
-25°C  
+70°C  
165,0 kg/km

## Norms

Halogen-free acc. to 60754-2

Halogen-free acc. to 60754-2

## Part no.

**400042**

**400043**

Dimensions and specifications may be changed without prior notice.

## Application

The multipaired HELUSOUND® special sound audio cable has individually shielded pairs and is protected by an additional braided shielding and ribbed PUR sheath. This cable is particularly suitable for use in mobile radio and transmission systems.

# Audio

## AES/EBU digital audio cables, single pair, with spiral screen

HELUSOUND®

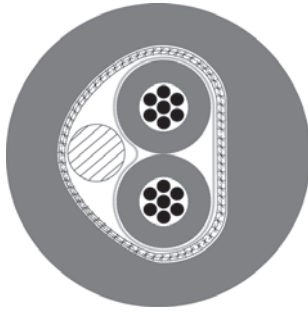

### Type

#### Cable structure

Conductor material:  
Core insulation:  
Core colours:  
Stranding element:  
Sheath material:  
Cable external diameter:  
Sheath colour:

### Digital audio cables

#### 2x0,22

Copper, bare  
PE  
rd, bu  
2 cores with 1 earth conductor  
PVC  
app. 5,0 mm  
black

### Electrical data

Characteristic impedance: 110 Ohm  
Conductor resistance, max.: 86 Ohm/km  
Insulation resistance, min.: 1 GOhm x km

### Technical data

Weight: app. 35 kg/km  
Min. bending radius for laying: 50 mm  
Operating temperature range min.: -25°C  
Operating temperature range max.: +70°C  
Copper weight: 14,7 kg/km

### Part no.

**400021**

Dimensions and specifications may be changed without prior notice.

### Application

The HELUSOUND® AES/EBU audio cable is a 2-core, symmetrical and shielded digital sound cable with flexible spiral screen and PVC outer sheath. The cable is suitable for longer transmission rates and larger data volumes, the transmission of digital and analog audio signals and can therefore, for example, be used for connecting audio amplifiers, digital mixers, DAT recorders etc. The cable is also available with PUR outer sheath.

# Audio

## AES/EBU digital audio cables, single pair, foil/braided screen

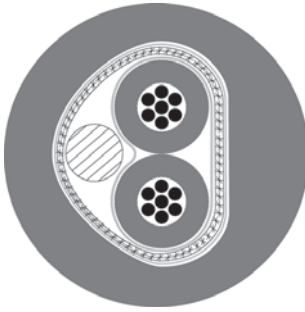

### Type

#### Cable structure

Conductor material:  
Core insulation:  
Core colours:  
Stranding element:  
Sheath material:  
Cable external diameter:  
Sheath colour:

### Digital audio cables

#### 2x0,22

Copper, tinned  
Cell PE  
rd, bu  
2 cores with 1 earth conductor  
PVC  
app. 6,0 mm  
black

### Electrical data

Characteristic impedance: 110 Ohm  
Conductor resistance, max.: 86 Ohm/km  
Insulation resistance, min.: 1 GOhm x km

### Technical data

Weight: app. 43 kg/km  
Min. bending radius for laying: 60 mm  
Operating temperature range min.: -25°C  
Operating temperature range max.: +70°C  
Copper weight: 16,5 kg/km

Part no.	Cable structure	Screen	Conductor resistance Ohm / km	Outer diameter app. mm	Cop. weight kg / km	Weight app. kg / km
400022	2x0,22	Foil + braid	< 86,0	6,0	16,5	43,0
400023	2x0,22	Foil + braid	< 86,0	4,5	15,7	25,0
400024	2x0,22	Foil	< 86,0	4,2	7,3	18,0

Dimensions and specifications may be changed without prior notice.

### Application

The HELUSOUND® AES/EBU audio cable is a 2-core, symmetrical and shielded digital sound cable. The cable is available in three different versions. The standard version is characterised by double shielding; the patch variant has reduced outside diameter and the foil shielded variant is suitable for the permanent wiring of digital devices. All three versions are suitable for the transmission of digital audio signals.



# Audio

**AES/EBU digital audio cables, multipaired, pairs with foil screen and overall foil screen**



## Type

### Cable structure

Conductor material:  
Core insulation:  
Core colours:  
Stranding element:  
Sheath material:  
Cable external diameter:  
Sheath colour:

## Digital audio cables

### 2x2x0,22

Copper, tinned  
Cell PE  
rd, bu  
2 cores with 1 earth conductor  
PVC  
app. 9,9 mm  
black

## Electrical data

Characteristic impedance: 110 Ohm  
Conductor resistance, max.: 86 Ohm/km  
Insulation resistance, min.: 1 GOhm x km

## Technical data

Weight: app. 85 kg/km  
Min. bending radius for laying: 100 mm  
Operating temperature range min.: -25°C  
Operating temperature range max.: +70°C  
Copper weight: 16,0 kg/km

Part no.	Cable structure	Outer diameter app. mm	Cop. weight kg / km	Weight app. kg / km
400025	2x2x0,22	9,9	16,0	85,0
400026	4x2x0,22	11,8	31,0	119,0
400027	6x2x0,22	14,9	46,0	195,0
400028	8x2x0,22	16,1	59,0	232,0
400029	12x2x0,22	19,1	85,0	330,0
400158	24x2x0,22	24,5	162,0	670,0

Dimensions and specifications may be changed without prior notice.

## Application

The multipaired, digital HELUSOUND® AES/EBU audio cable is characterised by its shielding in pairs, its element sheaths and by the additional overall sheath. This cable is suitable for the transmission of digital audio signals.

# Audio

**AES/EBU digital audio cables, multipaired, pairs with foil screen and overall foil screen, halogen-free**

**HELUSOUND®**

**NEW**

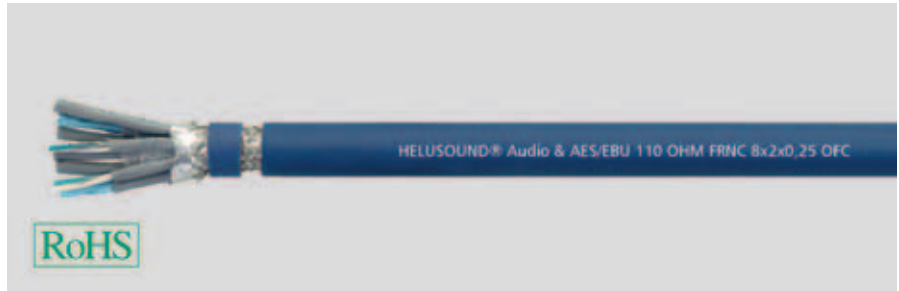

## Type

### Cable structure

Conductor material:  
Core insulation:  
Core colours:  
Stranding element:  
Sheath material:  
Cable external diameter:  
Sheath colour:

## Digital audio cables

### 2x2x0,25

Copper, bare  
Foam-skin-PE  
wh, tq  
2 cores with 1 filler  
LSZH soft  
app. 10,0 mm  
Blue similar to RAL 5015

## Electrical data

Characteristic impedance: 110 Ohm  
Conductor resistance, max.: 72 Ohm/km  
Insulation resistance, min.: 1 GOhm x km

## Technical data

Weight: app. 125 kg/km  
Min. bending radius for laying: 100 mm  
Operating temperature range min.: -20°C  
Operating temperature range max.: +80°C  
Copper weight: 32,0 kg/km

## Norms

Flame-retardant acc. to IEC 60332-1  
Corrosiveness acc. to EN50267-2-3

Part no.	Cable structure	Conductor resistance Ohm / km	Outer diameter app. mm	Cop. weight kg / km	Weight app. kg / km
400171	2x2x0,25	< 72,0	10,0	32,0	125,0
400172	4x2x0,25	< 72,0	11,9	55,0	175,0
400173	8x2x0,25	< 72,0	15,5	93,0	330,0
400174	12x2x0,25	< 72,0	19,9	139,0	450,0

Dimensions and specifications may be changed without prior notice.

## Application

The multipaired, digital HELUSOUND® AES/EBU audio cable is characterised by its shielding in pairs, its element sheaths and by the additional overall sheath. This cable is suitable for the transmission of digital audio signals.

# Audio & Light

## AES/EBU & DMX patch cable

**HELULIGHT**



### Type

#### Cable structure

Conductor material:

Core insulation:

Core colours:

Stranding element:

Sheath material:

Cable external diameter:

Sheath colour:

### DMX cables

#### 2x0,22

Copper, tinned

Cell PE

rd, bu

2 cores with 1 filler

PVC

app. 5,0 mm

blue

### Electrical data

Characteristic impedance:

Conductor resistance, max.:

Insulation resistance, min.:

110 Ohm

80 Ohm/km

5 GOhm x km

### Technical data

Weight:

Min. bending radius for laying:

Operating temperature range min.:

Operating temperature range max.:

Copper weight:

app. 33 kg/km

50 mm

-30°C

+70°C

14,0 kg/km

### Part no.

**400031**

Dimensions and specifications may be changed without prior notice.

### Application

The 2-core HELUSOUND® AES/EBU & DMX patch cable is foil shielded and optimally protected against external interference by its copper spiral screen. This cable is suitable for indoor use for permanent laying for the control of lighting systems or for patching in studio technology.



# Audio & Light

## AES/EBU & DMX cables

HELULIGHT®

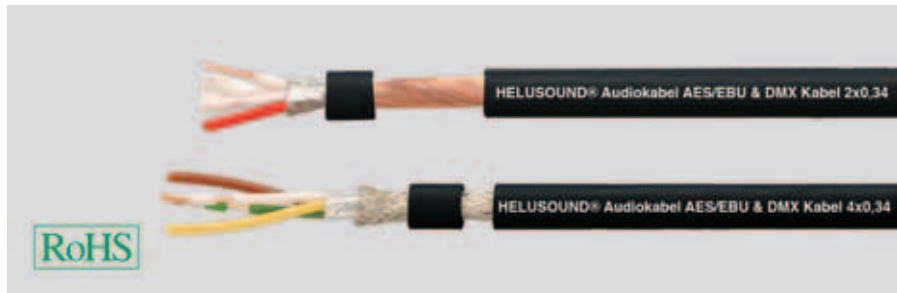

### Type

#### Cable structure

Conductor material:  
Core insulation:  
Core colours:  
Stranding element:  
Sheath material:  
Cable external diameter:  
Sheath colour:

### DMX cables

#### 2x0,34

Copper, bare  
Cell PE  
rd, wh  
2 cores with textile filler stranded  
PVC  
app. 6,4 mm  
black

### DMX cables

#### 4x0,34

Copper, bare  
Cell PE  
wh,gn,bn,ye  
Star quad  
PVC  
app. 7,0 mm  
black

### Electrical data

Characteristic impedance:  
Conductor resistance, max.:  
Insulation resistance, min.:

110 Ohm  
53 Ohm/km  
10 GOhm x km

110 Ohm  
53 Ohm/km  
5 GOhm x km

### Technical data

Weight:  
Min. bending radius for laying:  
Operating temperature range min.:  
Operating temperature range max.:  
Copper weight:

app. 50 kg/km  
64 mm  
-30°C  
+70°C  
18,0 kg/km

app. 65 kg/km  
70 mm  
-30°C  
+70°C  
29,0 kg/km

### Part no.

**400032**

**400033**

Dimensions and specifications may be changed without prior notice.

### Application

The 2-core HELUSOUND® AES/EBU & DMX patch cable is protected against external interferences by its copper spiral screen. This cable is suitable for permanent laying for the control of lighting systems or for connecting digital audio amplifiers. It can be installed indoors and outdoors. The max. transmission path for DMX control amounts approx. 1000m

# Audio & Light

AES/EBU TP DMX 512

HELULIGHT®

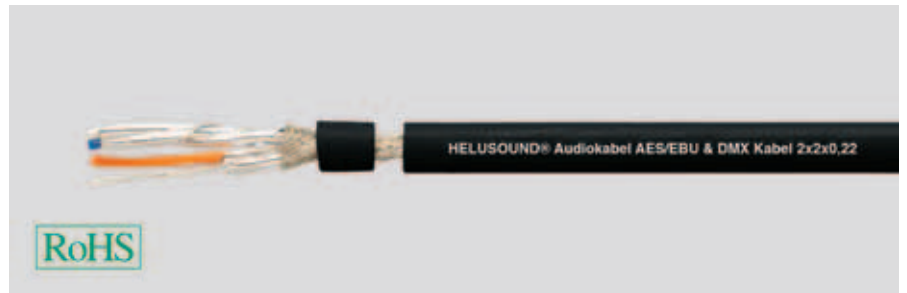
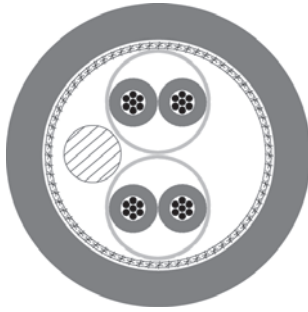

## Type

### Cable structure

Conductor material:  
Core insulation:  
Core colours:  
Stranding element:  
Sheath material:  
Cable external diameter:  
Sheath colour:

## DMX cables

### 2x2x0,22

Copper, tinned  
Cell PE  
or/wh, bu/wh  
pairs stranded  
PVC soft  
app. 8,0 mm  
black matt

## Electrical data

Characteristic impedance: 110 Ohm  
Conductor resistance, max.: 85 Ohm/km  
Insulation resistance, min.: 100 GOhm x km

## Technical data

Weight: app. 76 kg/km  
Min. bending radius for laying: 80 mm  
Operating temperature range min.: -25°C  
Operating temperature range max.: +70°C  
Copper weight: 38,0 kg/km

## Part no.

**400034**

Dimensions and specifications may be changed without prior notice.

## Application

The 4-core HELUSOUND® AES/EBU & DMX cable is protected against external interference by its AL/PT foil, its copper spiral screen and its PVC outer sheath. This cable is suitable for controlling all types of digital equipment. Also to use as microphone cable.

# Light & Power

DMX+POWER

HELULIGHT®

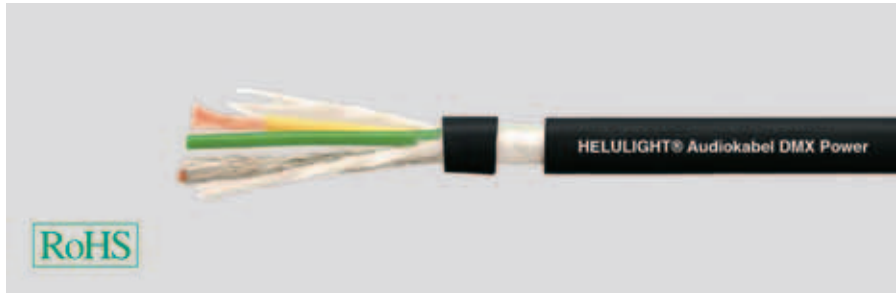
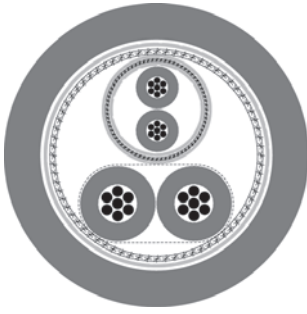

## Type

### Cable structure

Conductor material:  
Core insulation:  
Core colours:  
Stranding element:  
Sheath material:  
Cable external diameter:  
Sheath colour:

## DMX cables

### (1x2x0,24)+2x1,0

Copper, bare  
Foam-Skin-PE (DMX), PVC (Power)  
red, white (DMX); yellow, green (Power)  
2 cores with 1 filler  
PVC soft  
app. 7,4 mm  
black matt

## Electrical data

Characteristic impedance: 110 Ohm

## Technical data

Weight: app. 74 kg/km  
Copper weight: 36,0 kg/km

## Part no.

**400081**

Dimensions and specifications may be changed without prior notice.

## Application

The hybrid DMX Power cable is used in the professional DMX light controller. It transmits power for the light and control signals for the movement. The cable is compact, flexible and easy to process.

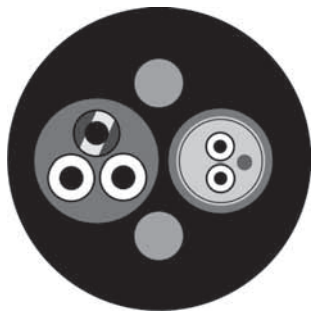

NEW

### Type

#### Cable structure

Conductor material:  
Core insulation:  
Core insulation 2:  
Core colours:  
Stranding element:  
Sheath material:  
Cable external diameter:  
Sheath colour:

### DMX cables

#### (1x2x0,25)+3G1,5

Copper, bare  
Foam-Skin-PE (DMX), PVC (Power)  
PVC  
red, white (DMX); brown, blue, green/yellow (Power)  
DMX-Element together with Power-Element and filler stranded  
PVC flexible at low temperatures  
app. 13,2 mm  
black

### Electrical data

Characteristic impedance: 110 Ohm  
Conductor resistance, max.: 78 Ohm/km  
Insulation resistance, min.: 20 GOhm x km

### Technical data

Weight: app. 50 kg/km  
Min. bending radius for laying: 64 mm  
Operating temperature range min.: -30°C  
Operating temperature range max.: +70°C  
Copper weight: 60,5 kg/km

### Part no.

**400151**

Dimensions and specifications may be changed without prior notice.

### Application

The HELUSOUND® DMX+POWER hybrid cable combines a shielded light control wire and the power supply wire. The DMX-cable, which is shielded by a tin-coated copper braiding is perfectly suited for the control of light systems and mixing boards (110 Ohm characteristic intrinsic impedance). It highlights a soft PVC insulation and it is qualified for the use at indoor and outdoor installations. The DMX cable can also be used for the transmission of audio signals such as a microphone wire or as a power supply wire for active loudspeaker systems.



# Audio

## Instrument cables with spiral screen

**HELUSOUND**

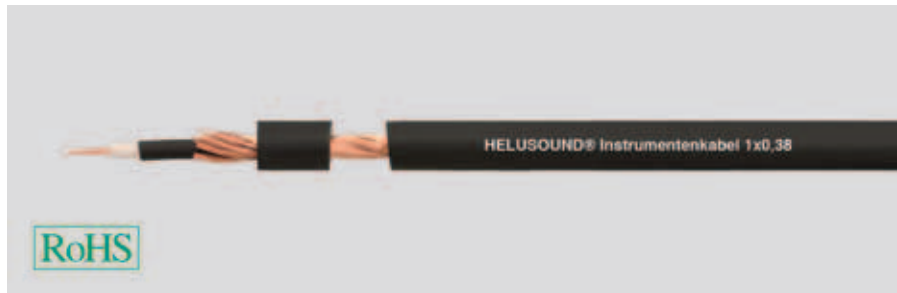
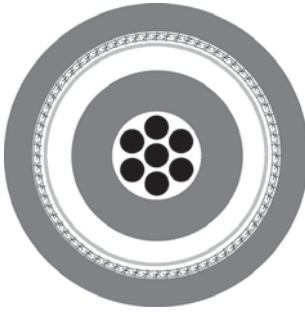

### Type

#### Cable structure

Conductor material:  
Core insulation:  
Sheath material:  
Cable external diameter:  
Sheath colour:

### Instrument cables

#### 1x0,22

Copper, bare  
Foam-skin-PE  
PVC  
app. 5,9 mm  
black

### Instrument cables

#### 1x0,38

Copper, bare  
Cell PE  
PVC  
app. 7,0 mm  
black

### Electrical data

Conductor resistance, max.:  
Insulation resistance, min.:

86 Ohm/km  
1 GOhm x km

55 Ohm/km  
1 GOhm x km

### Technical data

Weight:  
Min. bending radius for laying:  
Operating temperature range min.:  
Operating temperature range max.:  
Copper weight:

app. 44 kg/km  
60 mm  
-25°C  
+70°C  
7,9 kg/km

app. 55 kg/km  
70 mm  
-25°C  
+70°C  
29,0 kg/km

### Part no.

**400036**

**400037**

Dimensions and specifications may be changed without prior notice.

### Application

The HELUSOUND® instrument cable with spiral screen is a non-symmetrical, double shielded cable. This cable is specially suitable for connecting high ohmic components such as synthesisers, keyboards or guitars in professional stage and studio operation. The high-quality 1x0.38 special cable has an increased cross-section, a semi-conductor layer and a double spiral screen, which makes it suitable for the most stringent requirements of professional stages and studios.

# Audio

## Microphone cables with spiral screen, paired

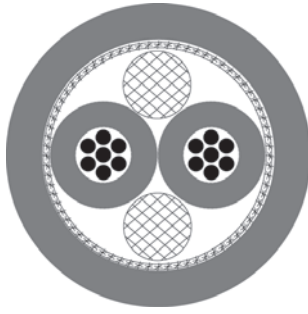

### Type

#### Cable structure

Conductor material:  
Core insulation:  
Core colours:  
Stranding element:  
Sheath material:  
Cable external diameter:  
Sheath colour:

#### Electrical data

Conductor resistance, max.:  
Insulation resistance, min.:

#### Technical data

Weight:  
Min. bending radius for laying:  
Operating temperature range min.:  
Operating temperature range max.:  
Copper weight:

#### Part no.

Dimensions and specifications may be changed without prior notice.

#### Application

The 2-core HELUSOUND® microphone cable with spiral screen is suitable for use in professional stage and studio operation. The microphone cable 2x0.15 has a double spiral screen made of bare copper wires.

#### Microphone cable

##### 2x0,22

Copper, bare  
PE  
rd, bu  
2 cores with textile filler stranded  
PVC  
app. 6,0 mm  
black

86 Ohm/km  
1 GOhm x km

app. 55 kg/km  
60 mm  
-25°C  
+70°C  
12,1 kg/km

#### 400038

#### Microphone cable

##### 2x0,15

Copper, bare  
PVC  
rd, wh  
pairs stranded  
PVC  
app. 4,2 mm  
black

120 Ohm/km  
1 GOhm x km

app. 27 kg/km  
42 mm  
-25°C  
+70°C  
14,0 kg/km

#### 400039

# Audio

## Microphone cables with braided screen

HELUSOUND®

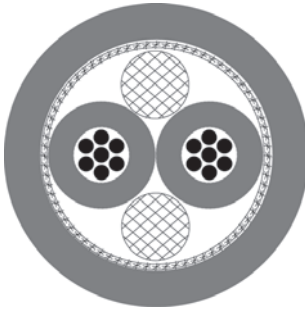

### Type

#### Cable structure

Conductor material:  
Core insulation:  
Core colours:  
Stranding element:  
Sheath material:  
Cable external diameter:  
Sheath colour:

#### Microphone cable 2x0,34

Copper, bare  
PE  
rd, bu  
2 cores with textile filler stranded  
PVC  
app. 6,5 mm  
black

#### Microphone cable 2x0,50

Copper, bare  
PE  
rd, wh  
2 cores with textile filler stranded  
PVC  
app. 6,7 mm  
black

#### Electrical data

Conductor resistance, max.:  
Insulation resistance, min.:

53 Ohm/km  
1 GOhm x km

37 Ohm/km  
1 GOhm x km

#### Technical data

Weight:  
Min. bending radius for laying:  
Operating temperature range min.:  
Operating temperature range max.:  
Copper weight:

app. 30 kg/km  
65 mm  
-30°C  
+70°C  
15,2 kg/km

app. 59 kg/km  
67 mm  
-30°C  
+70°C  
37,0 kg/km

#### Part no.

**400040**

**400080**

Dimensions and specifications may be changed without prior notice.

#### Application

The 2-wire HELUSOUND® microphone cable with copper braid shield is suitable for use in the professional stage and studio operations, as well as for fixed installation. The line is characterized by its highly flexible PVC jacket.

# Audio

## Microphone cables with braided screen, star quads

HELUSOUND®

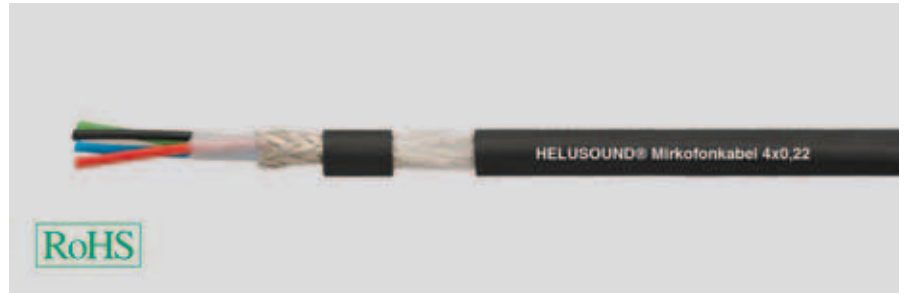

NEW

### Type

#### Cable structure

Conductor material:  
Core insulation:  
Core colours:  
Stranding element:  
Drain wire:  
Inner sheath material:  
Sheath material:  
Cable external diameter:  
Sheath colour:

### Microphone cable

#### 4x0,22

Copper, bare  
PE  
rd, bu, gn, bk  
Star quad  
AWG 26/7, copper bare  
PE  
PVC  
app. 6,1 mm  
black

### Microphone cable

#### 4x0,22

Copper, bare  
PE  
rd, bu, gn, bk  
Star quad  
AWG 26/7, tinned copper  
-  
FRNC  
app. 6,1 mm  
black

### Electrical data

Conductor resistance, max.:  
Insulation resistance, min.:

86 Ohm/km  
1 GOhm x km

86 Ohm/km  
1 GOhm x km

### Technical data

Weight:  
Min. bending radius for laying:  
Operating temperature range min.:  
Operating temperature range max.:  
Copper weight:

app. 50 kg/km  
62 mm  
-25°C  
+70°C  
25,0 kg/km

app. 50 kg/km  
62 mm  
-25°C  
+70°C  
25,0 kg/km

### Norms

-

Corrosiveness acc. to EN50267-2-3

### Part no.

**400041**

**400248**

Dimensions and specifications may be changed without prior notice.

### Application

The 4-core HELUSOUND® microphone cable is stranded in star quads and suitable for special application due to its earth conductor and braided shielding. It is e.g. used as a stereo cable in the area of professional studio and microphone technique. Easy stripping.



# Audio

## Microphone cables with spiral screen, halogen-free

HELUSOUND®

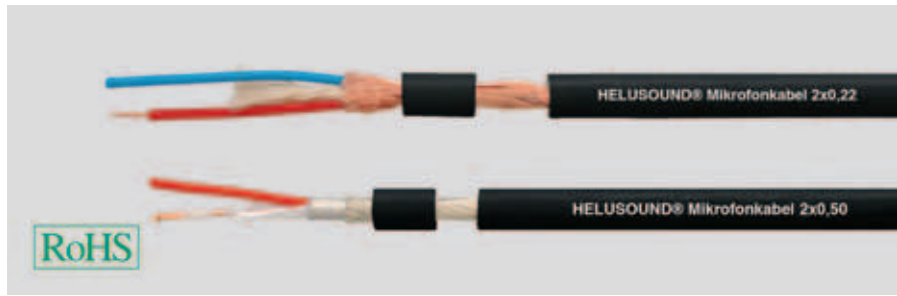

### Type

#### Cable structure

Conductor material:  
Core insulation:  
Core colours:  
Stranding element:  
Inner sheath material:  
Sheath material:  
Cable external diameter:  
Sheath colour:

#### Microphone cable 2x0,22

Copper, bare  
PE  
rd, bu  
2 cores with textile filler stranded  
PE  
FRNC  
app. 6,0 mm  
black

#### Microphone cable 2x0,50

Copper, bare  
PE  
rd, bu  
2 cores with textile filler stranded  
-  
FRNC  
app. 6,7 mm  
black

#### Electrical data

Conductor resistance, max.:  
Insulation resistance, min.:

87 Ohm/km  
1 GOhm x km

37 Ohm/km  
1 GOhm x km

#### Technical data

Weight:  
Min. bending radius for laying:  
Operating temperature range min.:  
Operating temperature range max.:  
Copper weight:

app. 45 kg/km  
72 mm  
-30°C  
+70°C  
9,0 kg/km

app. 59 kg/km  
80 mm  
-30°C  
+70°C  
37,0 kg/km

#### Norms

Corrosiveness acc. to EN50267-2-3

Corrosiveness acc. to EN50267-2-3

#### Part no.

400249

400250

Dimensions and specifications may be changed without prior notice.

#### Application

The 2-wire HELUSOUND® microphone cable with copper spiral screen is suitable for use in the professional stage and studio operations, as well as for fixed installation. The line is characterized by its highly flexible PVC jacket.

# Loudspeaker Cables

TWIN

HELUSOUND®

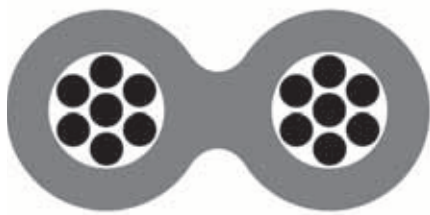

Cross section (mm <sup>2</sup> )	2 x 0,5	2 x 0,5	2 x 0,75	2 x 0,75	2 x 1,5	2 x 1,5	2 x 2,5	2 x 2,5	2 x 4	2 x 4
Part no.	40180	40023	40181	40024	40182	40025	40183	40026	40184	40027

## Cable structure

Conductor material: Copper litz wire, bare

Identification: Grooves

Cond. make-up	16 x 0,20	16 x 0,20	24 x 0,20	24 x 0,20	28 x 0,25	28 x 0,25	48 x 0,25	48 x 0,25	55 x 0,30	55 x 0,30
Insulation h x w mm	2,0 x 5,0	2,1 x 4,7	2,2 x 4,9	2,2 x 4,9	2,6 x 5,5	2,6 x 5,5	3,3 x 7,0	3,3 x 7,0	4,3 x 8,2	4,3 x 8,2
Sheath material	PVC	PVC	PVC	PVC	PVC	PVC	PVC	PVC	PVC	PVC
Sheath colour	transparent	black/red	transparent	black/red	transparent	black/red	transparent	black/red	transparent	black/red
Weight app. kg / km	15	15	20	20	37	37	63	63	80	80

## Electrical characteristics

### Loop resistance

max. (Ohm/km)

Capacitance pF/m	47	47	60	60	67	67	67	67	64	64
Inductance µH/m at										
1 kHz	0,7	0,67	0,61	0,61	0,54	0,54	0,54	0,54	0,58	0,58
10 kHz	0,8	0,79	0,73	0,73	0,59	0,59	0,62	0,62	0,65	0,65
100 kHz	0,8	0,85	0,73	0,73	0,59	0,59	0,62	0,62	0,65	0,65
1000 kHz	0,8	0,8	0,67	0,67	0,52	0,52	0,56	0,56	0,59	0,59
Copper weight kg/km	9,6	9,6	14,4	14,4	28,8	28,8	48,0	48,0	76,8	76,8

Cross section (mm <sup>2</sup> )	2 x 1,5	2 x 2,5	2 x 4	2 x 6	2 x 10
Part no.	40185	40186	40187	40188	40189

## Cable structure

Conductor material: Bare copper litz wire, highly flexible

Identification: Stripes

Cond. make-up	189 x 0,10	322 x 0,10	511 x 0,10	777 x 0,10	1273 x 0,10
Insulation h x w mm	3,1 x 6,5	3,6 x 7,5	5 x 10,2	6,1 x 12,5	7,0 x 15,0
Sheath material	PVC	PVC	PVC	PVC	PVC
Sheath colour	transparent	transparent	transparent	transparent	transparent
Weight app. kg / km	41	60	79	136	254

## Electrical characteristics

### Loop resistance

max. (Ohm/km)

Capacitance pF/m	67	53	50	54	59
Inductance µH/m at					
1 kHz	0,54	0,48	0,49	0,46	0,45
10 kHz	0,61	0,55	0,56	0,54	0,53
100 kHz	0,62	0,59	0,6	0,56	0,56
1000 kHz	0,55	0,54	0,56	0,53	0,52
Copper weight kg/km	28,8	48,0	76,8	115,2	192,0

Dimensions and specifications may be changed without prior notice. (RM01)

## Note

The materials used in manufacture are cadmium-free, contain no silicone and are free from substances harmful to the wetting properties of lacquers.

# HELUSOUND® 400 PVC

Speaker cables, round

HELUSOUND®

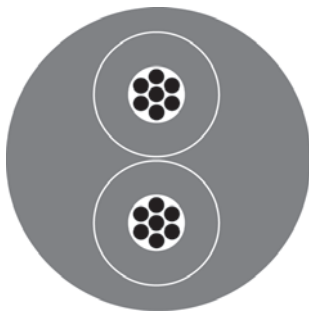

## Type

### Cable structure

Conductor material:  
Core insulation:  
Core colours:  
Sheath material:  
Cable external diameter:  
Sheath colour:

### Speaker cable HELUSOUND® 400 2x1,5

Copper, bare  
PVC  
rd, bk  
PVC  
app. 6,6 mm  
black

### Electrical data

Conductor resistance, max.: 12,7 Ohm/km

### Technical data

Weight: app. 73,4 kg/km  
Min. bending radius for laying: 33 mm  
Operating temperature range min.: -10°C  
Operating temperature range max.: +70°C  
Copper weight: 28,8 kg/km

Part no.	Cable structure	Conductor resistance Ohm / km	Outer diameter app. mm	Cop. weight kg / km	Weight app. kg / km
400089	2x1,5	< 12,7	6,6	28,8	73,4
400090	2x2,5	< 7,9	7,5	48,0	106,9
400091	2x4,0	< 4,9	9,4	76,8	163,7
400092	4x2,5	< 7,9	8,8	96,0	169,3
400093	4x4,0	< 4,9	11,6	153,6	272,4
400060	8x2,5	< 7,9	13,5	192,0	349,0
400094	8x4,0	< 4,9	16,8	307,2	541,6

Dimensions and specifications may be changed without prior notice.

## Application

All products of the HELUSOUND® 400 LOUDSPEAKER series impress with their extremely high flexibility. 0,15 stranded wires and a very soft PVC outer sheath make this possible. These cables are particularly used in mobile applications on stages, in studios or in the conference industry.

# HELUSOUND® 500 PUR

Speaker cables, round

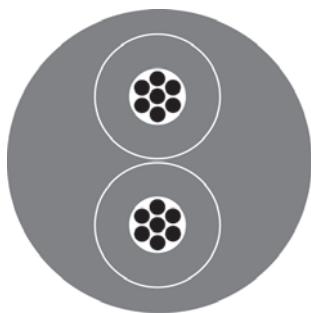

NEW

## Type

### Cable structure

Conductor material:  
Core insulation:  
Core colours:  
Stranding element:  
Sheath material:  
Cable external diameter:  
Sheath colour:

### Speaker cable HELUSOUND® 500 PUR 2x1,5

Copper, bare  
PVC  
rd, bk  
pairs stranded  
PUR  
app. 6,6 mm  
black

### Electrical data

Conductor resistance, max.: 12,7 Ohm/km

### Technical data

Weight: app. 66,9 kg/km  
Min. bending radius for laying: 33 mm  
Operating temperature range min.: -25°C  
Operating temperature range max.: +80°C  
Copper weight: 28,8 kg/km

Part no.	Cable structure	Conductor resistance Ohm / km	Outer diameter app. mm	Cop. weight kg / km	Weight app. kg / km
400109	2x1,5	< 12,7	6,6	28,8	66,9
400110	2x2,5	< 7,9	7,5	48,0	98,5
400111	2x4,0	< 4,9	9,4	76,8	150,2
400112	4x2,5	< 7,9	8,8	96,0	159,1
400113	4x4,0	< 4,9	11,6	153,6	253,0
400114	8x2,5	< 7,9	13,5	192,0	332,1
400115	8x4,0	< 4,9	16,8	307,2	499,5

Dimensions and specifications may be changed without prior notice.

### Application

The robust solution for medium and high mechanical stresses, as robust, abrasion-resistant and cut resistant. Also suitable for outdoor use.



# HELUSOUND® 600 FRNC

Speaker cables, round, halogen-free

HELUSOUND®

NEW

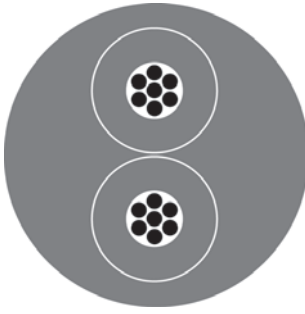

## Type

### Cable structure

Conductor material:  
Core insulation:  
Core colours:  
Stranding element:  
Sheath material:  
Cable external diameter:  
Sheath colour:

### Speaker cable HELUSOUND® 600 FRNC 2x1,5

Copper, bare  
FRNC  
rd, bk  
pairs stranded  
FRNC  
app. 6,6 mm  
black

### Electrical data

Conductor resistance, max.: 12,7 Ohm/km

### Technical data

Weight: app. 77 kg/km  
Min. bending radius for laying: 33 mm  
Operating temperature range min.: -5°C  
Operating temperature range max.: +70°C  
Copper weight: 28,8 kg/km

### Norms

Corrosiveness acc. to EN50267-2-3

Part no.	Cable structure	Conductor resistance Ohm / km	Outer diameter app. mm	Cop. weight kg / km	Weight app. kg / km
400116	2x1,5	< 12,7	6,6	28,8	77,0
400117	2x2,5	< 7,9	7,5	48,0	105,6
400118	2x4,0	< 4,9	9,4	76,8	166,9
400119	4x2,5	< 7,9	8,8	96,0	161,5
400120	4x4,0	< 4,9	11,6	153,6	271,6
400121	8x2,5	< 7,9	13,5	192,0	338,6
400122	8x4,0	< 4,9	16,8	307,2	531,5

Dimensions and specifications may be changed without prior notice.

### Application

The safe solution for increasing demands on the security in case of fire, as flame retardant, low smoke, halogen-free, no corrosion damage by released gases and fumes, no flame propagation provide for local flame propagation for the integrity of important systems.

# Audio

## Speaker cables, coaxial

HELUSOUND®

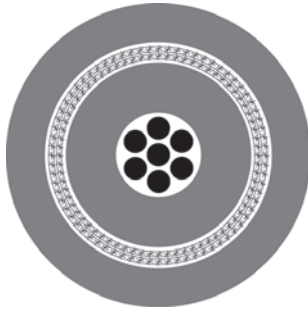

### Type

#### Cable structure

Conductor material:  
Core insulation:  
Core colours:  
Sheath material:  
Cable external diameter:  
Sheath colour:

#### Electrical data

Conductor resistance, max.:  
Insulation resistance, min.:

#### Technical data

Weight:  
Min. bending radius for laying:  
Operating temperature range min.:  
Operating temperature range max.:  
Copper weight:

#### Part no.

Dimensions and specifications may be changed without prior notice.

#### Application

The coaxial HELUSOUND® speaker cable is protected by a counter-rotating double spiral shield and outer jacket. It is characterized due to the construction, in addition to robustness and good drum reeling, especially by high flexibility and small dimensions.

### Speaker cable

#### 2x2,5

Copper, bare  
PVC  
Black  
PVC  
app. 6,8 mm  
black

7,98 Ohm/km  
5 MOhm x km

app. 84 kg/km  
68 mm  
-25°C  
+70°C  
52,0 kg/km

#### 400061

### Speaker cable

#### 2x4,0

Copper, bare  
PVC  
Black  
PVC  
app. 7,9 mm  
black

4,95 Ohm/km  
5 MOhm x km

app. 129 kg/km  
80 mm  
-25°C  
+70°C  
87,0 kg/km

#### 400062

# Loadcable 300/500 V + 600/1000 V

NEW

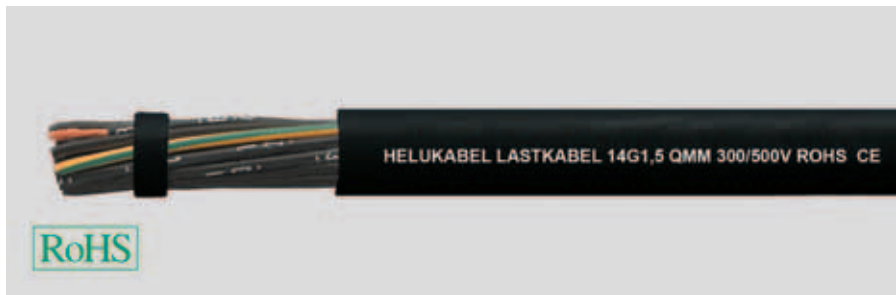

## Type

### Cable structure

Conductor material:  
Core insulation:  
Core colours:  
Stranding element:  
Sheath material:  
Cable external diameter:  
Sheath colour:

## Loadcable 300/500 V

Copper, bare  
PVC flexible at low temperatures  
black number coded + gn/ye  
14 cores stranded  
PVC flexible at low temperatures  
app. 13,4 mm  
black

### Electrical data

Conductor resistance, max.: 13,3 Ohm/km

### Technical data

Weight: app. 322 kg/km  
Min. bending radius for laying: 53,6 mm  
Operating temperature range min.: -40°C  
Operating temperature range max.: +80°C  
Copper weight: 201,6 kg/km

Part no.	Cable structure	Conductor resistance Ohm / km	Outer diameter app. mm	Cop. weight kg / km	Weight app. kg / km
400143	14 G 1,5	< 13,3	13,4	201,6	322,0
400144	18 G 1,5	< 13,3	15,2	259,2	422,0
400145	14 G 2,5	< 7,98	16,6	336,0	487,0
400146	18 G 2,5	< 7,98	19,0	432,0	634,0

Dimensions and specifications may be changed without prior notice.

## Application

The highly flexible loadcables are applied at medium mechanical stress in the professional stage and lighting technology, and other load circuits. The flexibility is achieved through the building with extra fine 0,15 mm<sup>2</sup> strands and the core and sheath insulation from cold-flexible PVC.



NEW

### Type

#### Cable structure

Conductor material:  
Core insulation:  
Core colours:  
Stranding element:  
Sheath material:  
Cable external diameter:  
Sheath colour:

### Loadcable 300/500 V 13G2,5

Copper, tinned  
TPE-O  
black number coded + gn/ye  
Cores stranded in layers  
TPU  
app. 17,8 mm  
black

#### Electrical data

Conductor resistance, max.: 8,21 Ohm/km

#### Technical data

Weight: app. 564 kg/km  
Min. bending radius for laying: 53,6 mm  
Operating temperature range min.: -40°C  
Operating temperature range max.: +80°C  
Copper weight: 308,7 kg/km

#### Norms

Flame-retardant acc. to IEC 60332-1-2  
Halogen-free acc. to 60754-1  
Corrosiveness acc. to EN50267-2-3

Part no.	Cable structure	Conductor resistance Ohm / km	Outer diameter app. mm	Cop. weight kg / km	Weight app. kg / km
400214	13G2,5	< 8,21	17,8	308,7	564,0
400234	7G4	< 5,09	17,8	269,0	502,0
400235	7G6	< 3,39	21,3	403,0	737,0

Dimensions and specifications may be changed without prior notice.

### Application

The highly flexible load cables are applied at medium mechanical stress in the professional stage and lighting technology, and other load circuits. The flexibility is achieved through the building with extra fine 0,15 mm<sup>2</sup> strands and the core and sheath insulation from cold-flexible PVC.





## VIDEO

<b>Designation</b>	<b>Page</b>
Video cable, 75 Ohm	<b>44</b>
Video cables, multicore	<b>45</b>
Camera cables	<b>46</b>
RG-Coaxial cables	<b>47</b>
RG-Coaxial cables	<b>48</b>
RG-Coaxial cables	<b>49</b>
RG-Coaxial cables	<b>50</b>
Halogen-free RG-Coaxial cables	<b>51</b>
CATV-Cables	<b>52</b>
SAT-Coaxial cables	<b>53</b>
Multimedia-Coaxial cables	<b>54</b>
SAT/BK-Coaxial cables	<b>55</b>
SAT/BK-Coaxial cables	<b>56</b>
RGB-COAX-CY / RGB-COAX-(St) Y	<b>57</b>

# Video

## Video cables, single core



used as	Indoors	Indoors, underground	Indoors	Indoors	Indoors, underground	Indoors	Indoors	Indoors	Indoors, outdoors
<b>Type</b>	<b>0,6/2,8</b>	<b>1,0/6,6</b>	<b>1,0/6,6 2YD</b>	<b>1,0/6,6</b>	<b>1,0/6,6D</b>	<b>0,6L/3,7</b>	<b>0,6/3,7</b>	<b>1,0/6,6D</b>	<b>0,6L/3,7+2x0,75</b>
Part no.	40022	40056	40175	40173	40073	40170	40171	40174	40028
<b>Cable structure</b>									
Inner conductor Ø mm	0,6	1	1	1	1	0,2	0,6	1	0,6
	Copper, bare	Copper, bare	Copper, bare	Copper, bare	Copper, bare	Copper, bare	Copper, bare	Copper, bare	Copper, bare
Insulation Ø mm	2,8 Cell PE	6,4 PE	6,4 PE	6,4 PE	6,4 PE	3,7 PE	3,7 PE	6,4 PE	3,7 PE
1st Outer conductor	Polyester foil coated with aluminium on both sides	Bare copper braid	Bare copper braid	Bare copper braid	Bare copper braid	Bare copper braid	Bare copper braid	Bare copper braid	Bare copper braid
Ø app. mm	-	7	7	7	7	4,2	4,3	7	-
Inner sheath/Foil	-	-	PE	-	Foil	-	-	Foil	-
Ø app. mm	-	-	8,5	-	-	-	-	-	-
2nd Outer conductor	Tinned copper braid	no	Bare copper braid	no	Bare copper braid	no	no	Bare copper braid	-
Ø app. mm	-	-	9,1	-	7,6	-	-	7,6	-
Outer sheath	FRNC	PE	PVC	PVC	PE	PVC	PVC	PVC	PVC
Sheath colour	green	black	green	green	black	green	green	green	black
Outer Ø app. mm	4,3	8,8	11,0	8,8	9,0	6,1	6,1	9,0	11,8
Min. bending radius app. mm	25	45	55	45	50	30	30	50	50
Weight app. kg / km	24	93	151	95	125	48	48	128	85
<b>Electrical characteristics</b>									
<b>Impedance (Ohm)</b>	<b>75 ± 2</b>	<b>75 ± 1</b>	<b>75 ± 1</b>	<b>75 ± 1</b>	<b>75 ± 1</b>	<b>75 ± 1</b>	<b>75 ± 1</b>	<b>75 ± 1</b>	<b>75 ± 3</b>
Attenuation at 20°C (db/100m)									
1 MHz	0,9	0,6	0,6	0,6	0,6	1,2	1,1	0,6	1,1
5 MHz	2,2	1,3	1,4	1,3	1,4	2,6	2,5	1,4	2,5
7 MHz	2,6	-	-	-	-	-	-	-	-
10 MHz	3,2	2	2	2	2	3,6	3,5	2	3,5
50 MHz	7,5	-	-	-	-	-	-	-	-
100 MHz	10,2	-	-	-	-	-	-	-	-
Propagation velocity v/c	0,8	0,66	0,66	0,66	0,66	0,66	0,66	0,66	0
<b>DC resistance at 20°C</b>									
Inner conductor max.Ohm/km	63	22	24	22	24	83	63	24	63
Outer conductor max.Ohm/km	21	7,5	6,5	7,5	3,5	12,5	13	3,5	13
Capacitance pF/m	54	67	67	67	67	67	67	67	67
Test voltage (50 Hz, kVeff.)	3,5	7	7	7	7	4,2	4,2	7	4
<b>Working voltage at (kV)</b>									
Pulse operation	-	6	6	6	6	3,6	3,6	6	-
HF-operation (peak value)	-	3	3	3	3	1,8	1,8	3	-
DC operation	-	14	14	14	14	8	8	14	-
Screening efficiency (dB)									
50 and 900 MHz≥	90	-	-	-	-	-	-	-	-
Copper weight kg/km	11,0	32,0	78,0	32,0	78,0	22,0	22,0	78,0	38,0

Dimensions and specifications may be changed without prior notice. (RM01)

### Note

- The materials used in manufacture are cadmium-free and contain no silicone and free from substances harmful to the wetting properties of lacquers.
- **ALPR**=Polyesterfoil coated with Aluminium on both sides  
**bl**=Bare, **bk**=Black, **Cu**=Copper, **D**=2xbraiding, **FRNC**=Flame Retardant Non-Corrosive, **G**=Braid, **gn**=Green, **PE**=Polyethylene, **PEE**=Cell-PE, **PVC**=Polyvinylchloride

# Video

## Video cables, multicore

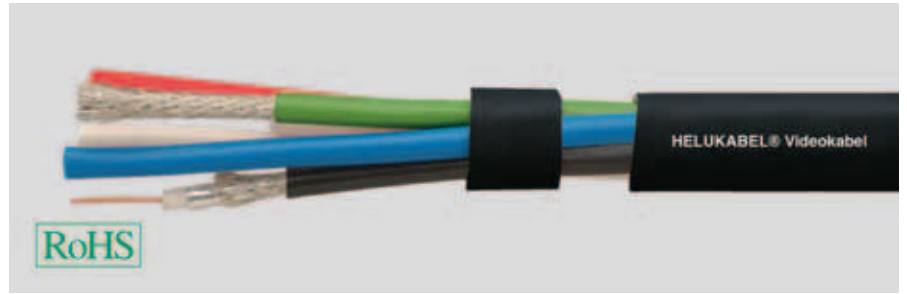

### Type

#### Cable structure

Conductor material:

Core insulation:

Sheath material:

Cable external diameter:

Sheath colour:

### Video Cables

#### 3x(0,6/2,8)

Copper, bare

Cell PE

PVC

app. 12,9 mm

black

### Electrical data

Characteristic impedance:

75 Ohm

Inner conductor resistance, max.:

65 Ohm/km

### Technical data

Weight:

app. 178 kg/km

Min. bending radius for laying:

130 mm

Operating temperature range min.:

-25°C

Operating temperature range max.:

+70°C

Copper weight:

49,0 kg/km

Part no.	Cable structure	Outer diameter app. mm	Cop. weight kg / km	Weight app. kg / km
400068	3x(0,6/2,8)	12,9	49,0	178,0
400069	4x(0,6/2,8)	14,1	65,0	214,0
400070	5x(0,6/2,8)	15,3	81,0	259,0
400071	6x(0,6/2,8)	16,7	97,0	295,0
400072	7x(0,6/2,8)	16,7	113,0	310,0

Dimensions and specifications may be changed without prior notice.

### Application

The multi-core, coaxial HELUKABEL® video cable is distinguished by 75 Ohm, cell PE insulation, AL foil and braided shielding, PVC element sheath and outer sheath. Alternative we also offer a halogen-free and flame-resistant version. As example it is suitable for the parallel transmission of signals (e.g. RGB).

# Video

## Camera cables, Triax

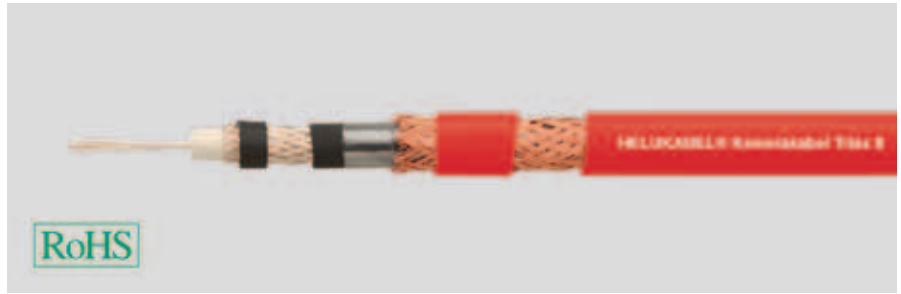
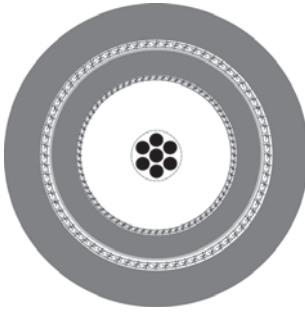

### Type

#### Cable structure

Conductor material:  
Core insulation:  
Sheath material:  
Cable external diameter:  
Sheath colour:

### Camera Cables

#### Triax 8

Copper, silvered  
PE  
PUR  
app. 8,5 mm  
red

### Electrical data

Characteristic impedance: 75 Ohm

### Technical data

Weight: app. 95 kg/km  
Min. bending radius for laying: 80 mm  
Operating temperature range min.: -30°C  
Operating temperature range max.: +80°C  
Copper weight: 55,0 kg/km

Part no.	Cable structure	Conductor insulation mm	Outer diameter app. mm	Cop. weight kg / km	Weight app. kg / km
400073	Triax 8	4,5	8,5	55,0	95,0
400074	Triax 11	6,5	11,0	80,0	150,0
400075	Triax 14	9,7	14,4	128,0	235,0
400076	Triax 8 flex	4,5	8,5	55,0	105,0
400077	Triax 11 flex	6,1	11,2	80,0	160,0
400078	Triax 14 flex	9,7	14,4	133,0	250,0

Dimensions and specifications may be changed without prior notice.

### Application

The HELUKABEL® Triax cable ensures the optimal transmission of image signals. This is possible because of the low attenuation values, thick cross-braided shielding and an especially rugged outer sheath. For the Flex variant, the PVC inner and outer sheath are replaced by TPE to guarantee greater flexibility. The Triax cables are primarily used to connect video cameras and image transmission systems and are suitable for mobile use.



# RG-Coaxial Cables



Type	RG 6 A/U	RG 11 A/U	RG 58 C/U	RG 59 B/U	RG 62 A/U	RG 71 B/U
Part no.	40001	40002	40003	40004	40005	40006
<b>Cable structure</b>						
Inner conductor Ø mm	1 x 0,7 Steel/copper, bare	7 x 0,4 Tinned copper	19 x 0,2 Tinned copper	1 x 0,6 Steel/copper, bare	1 x 0,6 Steel/copper, bare	1 x 0,6 Steel/copper, bare
Insulation Ø mm	4,7 PE	7,3 PE	2,95 PE	3,7 PE	3,7 PE, hollow	3,7 PE, hollow
Outer conductor	2 braids Silvered copper Copper, bare	Braid Copper, bare	Braid Tinned copper	Braid Copper, bare	Braid Copper, bare	2 braids Copper, bare Tinned copper
Outer sheath	PVC	PVC	PVC	PVC	PVC	PVC
Min. bending radius app. mm	40	50	25	30	30	30
Temperature range °C	-35 to +80	-35 to +80	-35 to +80	-35 to +80	-35 to +80	-50 to +70
Copper weight kg/km	72,0	58,0	29,0	28,0	28,0	48,0
Outer Ø app. mm	8,4	10,3	5,0	6,2	6,2	6,2
Weight app. kg / km	115	140	38	57	52	62
<b>Electrical characteristics</b>						
<b>Impedance (Ohm)</b>	<b>75 ± 3</b>	<b>75 ± 3</b>	<b>50 ± 2</b>	<b>75 ± 3</b>	<b>93 ± 5</b>	<b>93 ± 3</b>
Frequency range						
f (max.) GHz	3	3	3	3	3	3
Propagation velocity v/c	0,7	0,7	0,7	0,7	0,8	0,8
Attenuation at 20°C (db/100m)						
100 MHz	8,8	7,5	17	11,5	10,5	10,5
200 MHz	13,5	11	24	16,5	15	15
500 MHz	21	18,5	39	27	24,5	24,5
800 MHz	27,5	24	51	35	32,5	32,5
1000 MHz	-	30	56	41	35	-
1350 MHz	-	-	-	-	-	-
1750 MHz	-	-	-	-	-	-
Capacitance pF/m	67	67	101	67	42,5	42,5
Rel. velocity of propagation %	67	67	67	67	83	83
Insulation resistance MΩ x kmmin.	10 <sup>5</sup>	10 <sup>5</sup>	10 <sup>5</sup>	10 <sup>5</sup>	10 <sup>5</sup>	10 <sup>5</sup>
Loop resistance max. (Ω/km)	110	23	53	171	155	136
Nominal peak voltage kVs	3	5	2	4	1	2
Dielectric strength 50 Hz kV eff	7	10	5	7	3	3

Dimensions and specifications may be changed without prior notice. (RM01)

## Note

- The materials used in manufacture are cadmium-free and contain no silicone and free from substances harmful to the wetting properties of lacquers.
- RG-Coaxial types are in accordance with US-Military specifications MIL-C-17.
- RG/U: R=Radio, G=Guide, U=Utility

## Application

Coaxial cables are used in high frequency transmission, especially for transmitters and receivers, computers, radio and TV transmissions. The varied mechanical, thermal and electronic properties of Coaxial cables mean that they can be used up into the GHz levels, as per cable type.

# RG-Coaxial Cables



Type	RG 174 A/U	RG 174 U	RG 178 B/U	RG 179 B/U	RG 180 B/U	RG 187 A/U
Part no.	40197	400189	40007	40008	40009	40010
<b>Cable structure</b>						
Inner conductor Ø mm	7 x 0,2 Steel/copper, bare	7 x 0,2 Steel/copper, bare	7 x 0,1 Steel/copper, silvered	7 x 0,1 Steel/copper, silvered	7 x 0,1 Steel/copper, silvered	7 x 0,1 Steel/copper, silvered
Insulation Ø mm	1,52 PE	1,52 PE	0,86 PTFE	1,6 PTFE	2,6 PTFE	1,6 PTFE
Outer conductor	Braid Tinned copper	Braid Tinned copper	Braid Silvered copper	Braid Silvered copper	Braid Silvered copper	Braid Silvered copper
Outer sheath	PVC	PVC	FEP	FEP	FEP	PFA
Min. bending radius app. mm	15	15	10	15	25	15
Temperature range °C	-35 to +80	-35 to +80	-55 to +200	-55 to +200	-55 to +200	-55 to +260
Copper weight kg/km	7,0	7,0	7,0	8,0	11,0	9,0
Outer Ø app. mm	2,8	2,6	1,8	2,5	3,7	2,6
Weight app. kg / km	11	11	8	16	28	17

## Electrical characteristics

Impedance (Ohm)	50 ± 2	50 ± 2	50 ± 2	75 ± 3	95 ± 5	75 ± 3
Frequency range						
f (max.) GHz	1	1	3	3	3	3
Propagation velocity v/c	0,7	0,7	0,7	0,7	0,7	0,7
Attenuation at 20°C (db/100m)						
100 MHz	30	30	43	28	20	28
200 MHz	45	45	62	41	33	41
500 MHz	73	73	102	69	-	69
800 MHz	93	93	134	92	-	92
1000 MHz	-	-	-	-	-	-
1350 MHz	-	-	-	-	-	-
1750 MHz	-	-	-	-	-	-
Capacitance pF/m	101	101	93	63	50	64
Rel. velocity of propagation %	70	70	70	70	70	70
Insulation resistance MΩ x kmmin.	10 <sup>5</sup>	10 <sup>5</sup>	10 <sup>5</sup>	10 <sup>5</sup>	10 <sup>5</sup>	10 <sup>5</sup>
Loop resistance max. (Ω/km)	360	360	860	840	840	840
Nominal peak voltage kVs	1	1	1	1	2	1
Dielectric strength 50 Hz kV eff	2	2	2	2	2	2
	-	-	-	-	-	-

Dimensions and specifications may be changed without prior notice.

## Note

- The materials used in manufacture are cadmium-free and contain no silicone and free from substances harmful to the wetting properties of lacquers.
- The colour at FEP and PFA outer sheath is brown or white as per production outlet.
- RG-Coaxial types are in accordance with US-Military specifications MIL-C-17.
- RG/U: R=Radio, G=Guide, U=Utility

## Application

Coaxial cables are used in high frequency transmission, especially for transmitters and receivers, computers, radio and TV transmissions. The varied mechanical, thermal and electronic properties of Coaxial cables mean that they can be used up into the GHz levels, as per cable type.

# RG-Coaxial Cables



Type	RG 213	RG 213 LL	RG 214 U	RG 59 B/U TWIN
Part no.	40012	400168	40011	400190
<b>Cable structure</b>				
Inner conductor Ø mm	7 x 0,8 Copper, bare	7 x 1 Copper, bare	7 x 0,8 Silvered copper	7 x 0,6 Steel/copper, bare
Insulation Ø mm	7,24 PE	7,25 Cell PE, foamed	7,24 PE	3,7 PE
Outer conductor	Braid Copper, bare	foil Copper, bare	2 braids 2x silvered copper	Braid Copper, bare
Outer sheath	PVC	PVC	PVC	PVC
Min. bending radius app. mm	50	50	50	30
Temperature range °C	-35 to +80	-35 to +80	-35 to +80	-20 to +70
Copper weight kg/km	85,0	89,0	120,0	46,0
Outer Ø app. mm	10,3	10,2	10,8	12,6
Weight app. kg / km	159	166	198	102

## Electrical characteristics

Impedance (Ohm)	50 ± 2	50 ± 3	50 ± 2	75 ± 3
Frequency range				
f (max.) GHz	3	3	11	3
Propagation velocity v/c	0,7	0,8	0,7	0,7
Attenuation at 20°C (db/100m)				
100 MHz	7	4,3	7	11,1
200 MHz	10,2	5,8	10,2	16,8
500 MHz	17	9,6	17	27
800 MHz	23	12,9	23	35,1
1000 MHz	-	15	-	39,2
1350 MHz	-	-	-	-
1750 MHz	-	-	-	-
Capacitance pF/m	101	82	101	67
Rel. velocity of propagation %	100	67	67	67
Insulation resistance MΩm x kmmin.	10 <sup>5</sup>	-	10 <sup>5</sup>	-
Loop resistance max. (Ωm/km)	10	10	10	10
Nominal peak voltage kVs	5	0	5	0
Dielectric strength 50 Hz kV eff	10	0	10	0

Dimensions and specifications may be changed without prior notice.

## Note

- The materials used in manufacture are cadmium-free and contain no silicone and free from substances harmful to the wetting properties of lacquers.
- The colour outer sheath at PTFE is brown or transparent as per production outlet.
- RG-Coaxial types are in accordance with US-Military specifications MIL-C-17.
- RG/U: R=Radio, G=Guide, U=Utility

## Application

Coaxial cables are used in high frequency transmission, especially for transmitters and receivers, computers, radio and TV transmissions. The varied mechanical, thermal and electronic properties of Coaxial cables mean that they can be used up into the GHz levels, as per cable type.

# RG-Coaxial Cables

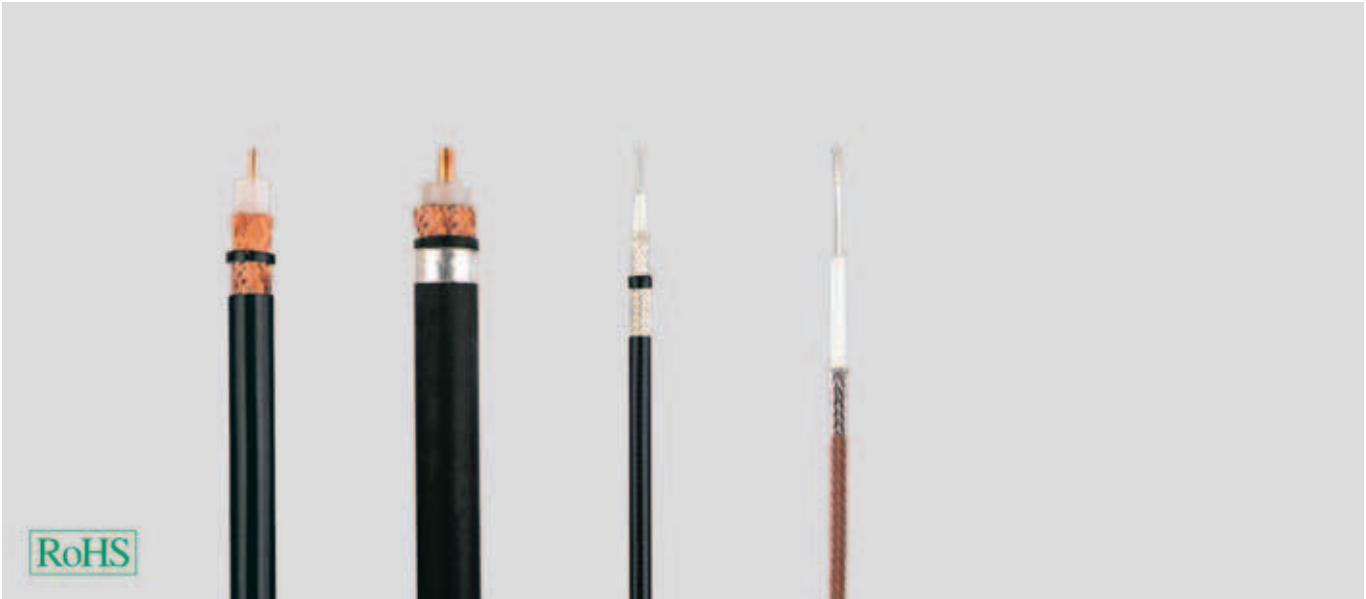

Type	RG 217	RG 218	RG 223 U	RG 316 B/U
Part no.	40200	40201	40202	40203
<b>Cable structure</b>				
Inner conductor Ø mm	1 x 2,7 Copper, bare	1 x 4,95 Copper, bare	1 x 0,9 Silvered copper	7 x 0,2 Steel/copper, silvered
Insulation Ø mm	9,4 PE	17,3 PE	2,95 PE	1,52 PTFE
Outer conductor	2 braids Copper, bare	Braid Copper, bare	2 braids 2x silvered copper	Braid Silvered copper
Outer sheath	PVC	PVC	PVC	PTFE/ alt. FEP
Min. bending radius app. mm	70	110	25	15
Temperature range °C	-35 to +80	-35 to +80	-35 to +80	-55 to +200
Copper weight kg/km	187,0	348,0	44,0	9,0
Outer Ø app. mm	13,84	22,1	5,2	2,5
Weight app. kg / km	300	710	60	15

## Electrical characteristics

Impedance (Ohm)	50 ± 2	50 ± 2	50 ± 2	50 ± 2
Frequency range				
f (max.) GHz	3	3	3	3
Propagation velocity v/c	0,66	0,66	0,7	0,7
Attenuation at 20°C (db/100m)				
100 MHz	4,8	2,9	17	28
200 MHz	7,1	4,5	23	40
500 MHz	12,3	8,1	38	68
800 MHz	16,8	11,2	50	90
1000 MHz	-	-	-	-
1350 MHz	-	-	-	-
1750 MHz	-	-	-	-
Capacitance pF/m	101	101	101	95
Rel. velocity of propagation %	100	100	67	70
Insulation resistance MΩm x kmmin.	10 <sup>5</sup>	10 <sup>5</sup>	10 <sup>5</sup>	10 <sup>5</sup>
Loop resistance max. (Ohm/km)	5	2	36	310
Nominal peak voltage kVs	7	11	2	1
Dielectric strength 50 Hz kV eff	10	15	5	2
	-	-	-	-

Dimensions and specifications may be changed without prior notice.

## Note

- The materials used in manufacture are cadmium-free and contain no silicone and free from substances harmful to the wetting properties of lacquers.
- The colour outer sheath at PTFE is brown or transparent as per production outlet.
- RG-Coaxial types are in accordance with US-Military specifications MIL-C-17.
- RG/U: R=Radio, G=Guide, U=Utility

## Application

Coaxial cables are used in high frequency transmission, especially for transmitters and receivers, computers, radio and TV transmissions. The varied mechanical, thermal and electronic properties of Coaxial cables mean that they can be used up into the GHz levels, as per cable type.

# RG-Coaxial Cables

halogen-free

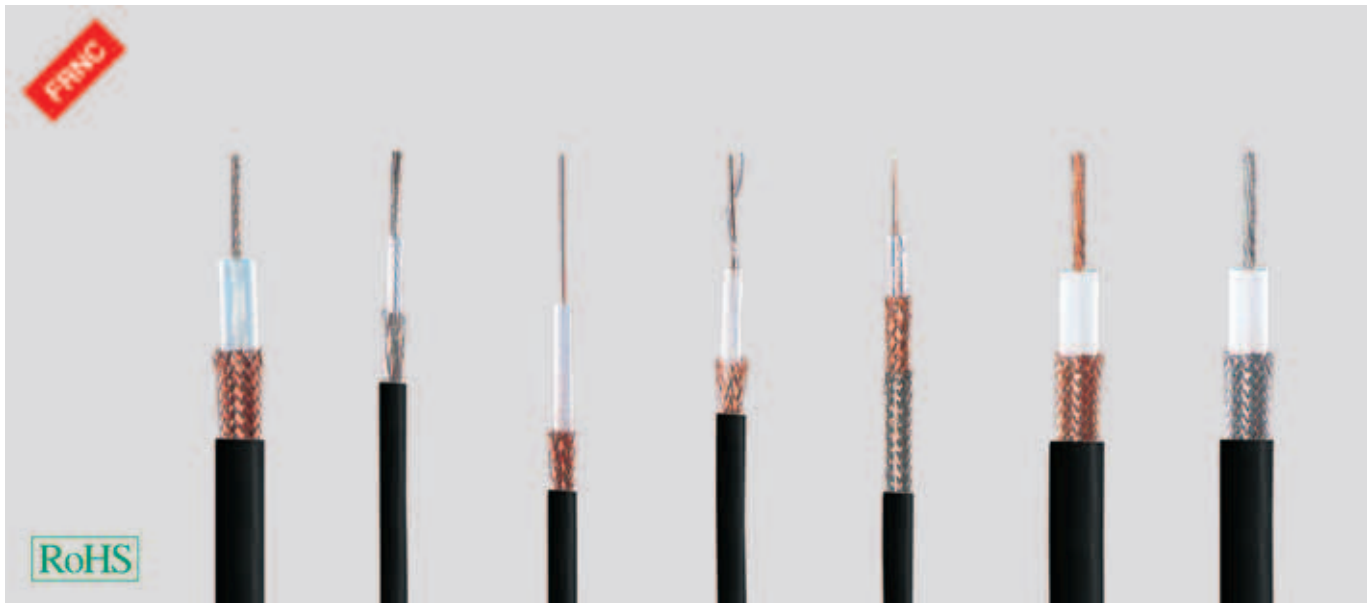

Type RG.../U	11 A/U	58 C/U	59 B/U	62 A/U	71 B/U	213 U	214 U
Part no.	40190	40191	40192	40193	40194	40195	40196

## Cable structure

Inner conductor Ø mm	7 x 0,4 Tinned copper	19 x 0,2 Tinned copper	1 x 0,6 Steel/copper, bare	1 x 0,6 Steel/copper, bare	1 x 0,6 Steel/copper, bare	7 x 0,8 Copper, bare	7 x 0,8 Silvered copper
Insulation Ø mm	7,3 PE	2,95 PE	3,7 PE	3,7 PE, hollow	3,7 PE, hollow	7,24 PE	7,24 PE
Outer conductor	Braid Copper, bare	Braid Tinned copper	Braid Copper, bare	Braid Copper, bare	2 braids Copper, bare Tinned copper	Braid Copper, bare	2 braids 2x silvered copper
Outer sheath	HM2	HM2	HM2	HM2	HM2	HM2	HM2
Min. bending radius app. mm	50	25	30	30	30	50	50
Temperature range °C	-35 to +80	-35 to +80	-35 to +80	-35 to +80	-50 to +70	-35 to +80	-35 to +80
Copper weight kg/km	58,0	29,0	28,0	28,0	48,0	85,0	120,0
Outer Ø app. mm	10,3	5,4	6,4	6,4	6,9	10,3	10,8
Weight app. kg / km	144	38	57	54	64	155	203

## Electrical characteristics

Impedance (Ohm)	75 ± 3	50 ± 2	75 ± 3	93 ± 5	93 ± 3	50 ± 2	50 ± 2
Frequency range							
f (max.) GHz	3	3	3	3	3	3	11
Propagation velocity v/c	0,7	0,7	0,7	0,8	0,8	0,7	0,7
Attenuation at 20 °C (db/100m)							
3 MHz	1,3	2,9	2	2	2	1,2	1,2
10 MHz	2,4	5,3	3,8	3,7	3,7	2,3	2,3
100 MHz	7,8	17	12,2	12	12,5	7,5	7,5
200 MHz	11,3	24,4	17,6	17,3	17,3	10,9	10,9
500 MHz	18,7	39,2	27,2	24,7	24,7	17,2	17,2
800 MHz	23,4	47,8	35,2	34,6	34,6	22,6	22,6
Capacitance pF/m	68	0	68	42,5	42,5	101	101
Rel. velocity of propagation %	67	67	67	43	43	101	101
Insulation resistance MOhm x kmmin.	10 <sup>5</sup>	10 <sup>5</sup>	10 <sup>5</sup>	10 <sup>5</sup>	10 <sup>5</sup>	10 <sup>5</sup>	10 <sup>5</sup>
Loop resistance max. (Ohm/km)	23	53	171	155	136	10	10
Nominal peak voltage kVs	5	2	2	1	1	5	5
Dielectric strength 50 Hz kVeff.	10	5	7	3	3	10	10

Dimensions and specifications may be changed without prior notice. (RM01)

## Note

- The materials used in manufacture are cadmium-free and contain no silicone and free from substances harmful to the wetting properties of lacquers.
- H-outer sheath = halogen-free material (HM2)
- RG-Coaxial types are in accordance with US-Military specifications MIL-C-17.
- RG/U: R=Radio, G=Guide, U=Utility
- FRNC = Flame Retardant Non-Corrosive

## Application

Coaxial cables are used in high frequency transmission, especially for transmitters and receivers, computers, radio and TV transmissions where no flame propagation under behaviour in fire is permitted. The varied mechanical, thermal and electronic properties of Coaxial cables mean that they can be used up into the GHz levels, as per cable type.



# CATV-Cables

screened

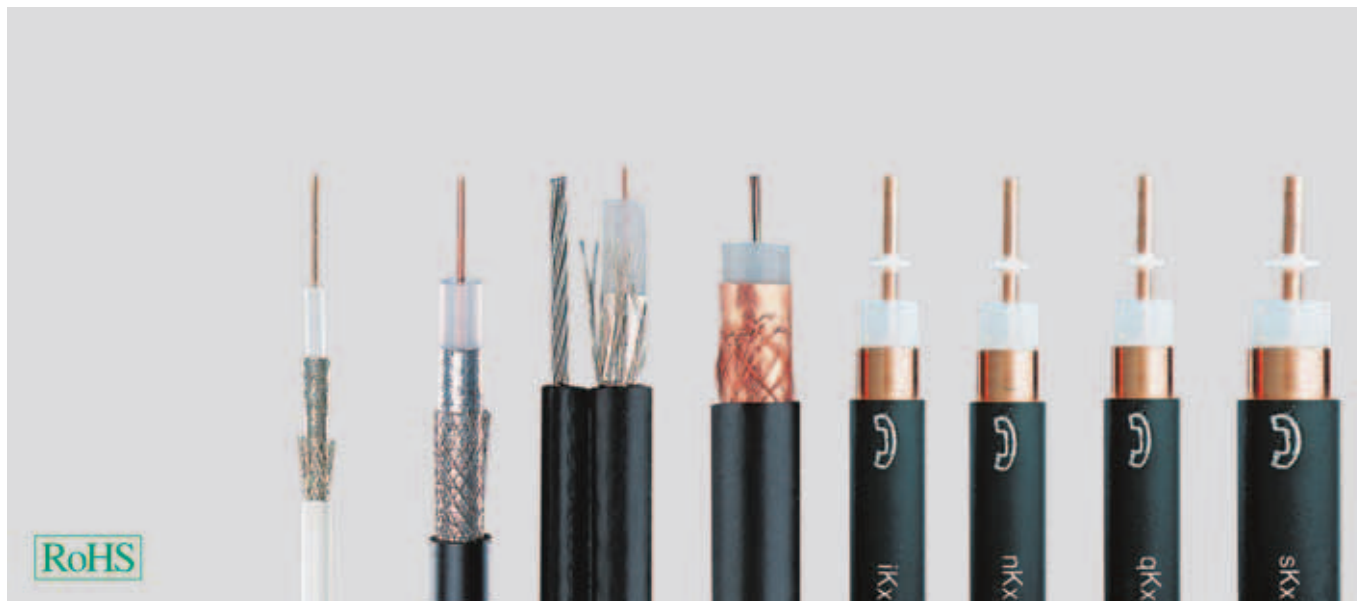

used as Type	0.7/4.4 ALG	Underground 1.1/7.3 ALG	Outdoor span 1.1/7.3 ALG-T	Underground 1.8/11.5 FG	BK-Underground A-2YK2Y1 iKx 1.1/7.3	BK-Underground A-2Y0K2Y1 nKx 2.2/8.8	BK-Underground A-2Y0K2Y1 qKx 3.3/13.5	BK-Underground A-2Y0K2Y1 sKx 4.9/19.4
Part no.	40135	40139	40140	40141	40142	40143	40144	40179
<b>Cable structure</b>								
Inner conductor Ø mm	0,7 Copper, bare	1,1 Copper, bare	1,1 Copper, bare	1,8 Copper, bare	1,1 Copper, bare	2,2 Copper, bare	3,3 Copper, bare	4,9 Copper, bare
Insulation Ø mm	4,4 PE	7,3 PE	7,3 PE	11,5 PE	7,3 PE	8,8 PE, hollow	13,5 PE, hollow	19,4 PE, hollow
Outer conductor	Polyester foil coated with aluminium on both sides Braid	Polyester foil coated with aluminium on both sides Braid	Polyester foil coated with aluminium on both sides Braid	Copper tape Braid	Copper tube, welded	Copper tube, welded	Copper tube, welded	Copper tube, welded
Outer sheath	PVC	PE	PE	PE	PE	PE	PE	PE
Sheath colour	white	black	black	black	black	black	black	black
Outer Ø app. mm	6,6	10,5	2,8	15,0	11,0	12,5	17,0	24,4
Min. bending radius app. mm	35	100	150	150	160	200	300	400
Strain /suspending wire N	-	-	5500	-	-	-	-	-
Weight app. kg / km	44	98	177	218	142	183	347	500
<b>Electrical characteristics</b>								
<b>Impedance (Ohm)</b>	<b>75 ± 3</b>	<b>75 ± 3</b>	<b>75 ± 3</b>	<b>75 ± 3</b>	<b>75 ± 2</b>	<b>75 ± 2</b>	<b>75 ± 1</b>	<b>75 ± 1</b>
Capacitance pF/m	67	67	67	67	65	51	51	50
Propagation velocity v/c	0,7	0,7	0,7	0,7	0,7	0,88	0,88	0,89
Attenuation at 20°C (db/100m)								
100 MHz	9	5,2	5,2	3,5	5,4	2,8	1,9	1,3
200 MHz	12	7,3	7,3	5,2	7,9	4	2,7	1,9
500 MHz	21,2	12,6	12,6	9	12,9	6,6	4,4	3,1
800 MHz	27,5	16,8	16,8	12	17,3	8,4	5,7	4,1
950 MHz	30,5	18,8	18,8	13	18,9	9,3	6,3	4,4
1350 MHz	37	23	23	-	-	-	-	-
1750 MHz	43	27,7	27,7	-	-	-	-	-
2050 MHz	47,5	30,2	30,2	-	-	-	-	-
Structural return loss min. (dB) between								
30 and 300 MHz	30	32	32	30	26	26	28	28
300 and 600 MHz	30	32	32	30	23	23	25	25
600 and 960 MHz	25	30	30	28	21	21	23	23
960 and 1750 MHz	23	27	27	25	-	-	-	-
<b>DC resistance at 20°C</b>								
Inner conductor max.Ohm/km	47	18,5	18,5	7,3	22	5,6	2,5	1
Outer conductor max.Ohm/km	23	11	11	6,5	3,1	3	2	1
<b>Screening efficiency (dB)</b>								
50 and 100 MHz≥	75	80	80	80	110	110	110	110
100 and 500 MHz≥	75	85	85	85	110	110	110	110
500 and 1000 MHz≥	75	85	85	85	110	110	110	110
1000 and 2050 MHz≥	75	78	78	80	110	110	110	110
<b>Post office approved</b>	G670009A	G670011A	G622015B	G622010B	-	-	-	-

Dimensions and specifications may be changed without prior notice. (RM01)

## Note

- The materials used in manufacture are cadmium-free and contain no silicone and free from substances harmful to the wetting properties of lacquers.
- BK-underground: broadband cable in accordance with FTZ 15 TV 11 (post cable)
- **AL**=Aluminium, **ALPR**=Polyesterfoil coated with Aluminium on both sides  
**BK-cable**=broadband communication cable, **Cu**=Copper, **CuR**=Cu-tube welded, **CuW**=Copperweld, **F**=Foil, **G**=Braid, **PE**=Polyethylene, **PEH**=Polyethylene air-space insulation, **PVC**=Polyvinylchloride

# SAT-Coaxial Cables

up to 2150 MHz, for satellite-receivers, double screened

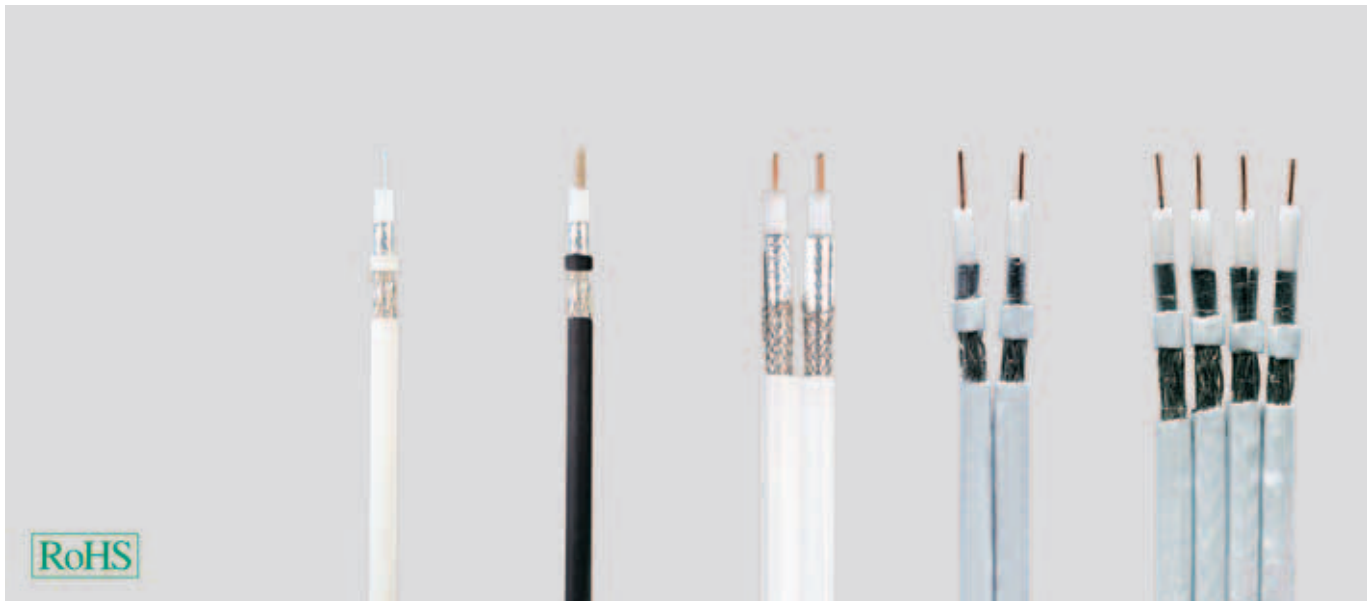

Type	1,1/4,8	1.65/7.2 ALG	SAT-MINI 1	DUO 2x0.7/2.9	QUADRO 4x0.7/2.9
Part no.	40150	40151	40159	40168	40169
<b>Cable structure</b>					
Inner conductor Ø mm	1,1 Tinned copper	1,6 Copper, bare	0,8 Copper, bare	0,65 Copper, bare	0,6 Copper, bare
Insulation Ø mm	5 Cell PE	7,2 Cell PE	3,5 Cell PE	3 Cell PE	3 Cell PE
Core colours	-	-	-	-	-
Outer conductor	Polyester foil coated with aluminium on both sides	Polyester foil coated with aluminium on both sides	Polyester foil coated with aluminium on both sides	Polyester foil coated with aluminium on both sides	Polyester foil coated with aluminium on both sides
	Braid	Braid	Braid	Braid	Braid
	-	-	-	-	-
Outer sheath	PVC	PE	PVC	PVC	PVC
Sheath colour	white	black	white	white	white
Outer Ø app. mm	6,8	10,1	5,4 x 10,8	8,6 x 4,3	20,0 x 4,3
Min. bending radius app. mm	50	60	40	35	80
Weight app. kg / km	49	81	62	40	82
<b>Electrical characteristics</b>					
<b>Impedance (Ohm)</b>	<b>75 ± 3</b>	<b>75 ± 3</b>	<b>75 ± 3</b>	<b>75 ± 3</b>	<b>75 ± 3</b>
Capacitance pF/m	55	55	55	55	55
Propagation velocity v/c	0,8	0,82	0,82	0,8	0,8
Attenuation at 20°C (db/100m)					
100 MHz	5	3,7	8	8,9	8,9
200 MHz	7,3	5,1	11,5	13,5	13,5
500 MHz	13	9	18,5	22	22
800 MHz	17,2	11,8	23,5	28	28
950 MHz	19,5	13,6	25,5	31,5	31,5
1350 MHz	23,5	16,8	31	37	37
1750 MHz	27,6	19,7	35,5	42,3	42,3
2050 MHz	30	22	39,5	45,9	45,9
2150 MHz	31	22,5	43	50,4	50,4
Structural return loss min. (dB) between					
30 and 300 MHz	28	31	27	20	20
300 and 600 MHz	28	30	25	17	18
600 and 960 MHz	26	30	20	17	15
960 and 2050 MHz	24	28	20	-	-
<b>DC resistance at 20°C</b>					
Inner conductor max.Ohm/km	18	9	36	110	52
Outer conductor max.Ohm/km	20	12	28	22	26
Max. nominal voltage (V)	-	-	-	-	-
<b>Screening efficiency (dB)</b>					
50 and 100 MHz≥	75	80	78	75	75
100 and 500 MHz≥	75	85	78	75	75
500 and 1000 MHz≥	75	85	75	75	75
1000 and 2050 MHz≥	75	78	75	75	75
<b>Post office approved</b>					
	G670010A	G622016B	-	-	-
Copper weight kg/km	21,0	35,0	30,0	16,0	50,0

Dimensions and specifications may be changed without prior notice. (RM01)

## Note

- The materials used in manufacture are cadmium-free and contain no silicone and free from substances harmful to the wetting properties of lacquers.
- **AL**=Aluminium, **ALPR**=Polyesterfoil coated with Aluminium on both sides  
**Cu**=Copper, **CuW**=Copperweld, **F**=Foil, **G**=Braid, **PE**=Polyethylene, **PEH**=Polyethylene air-space insulation, **PVC**=Polyvinylchloride, **vz**=tinned

# Multimedia-Coaxial Cables

SAT 1,0/4,6GH, up to 2400MHz, for digital-tv, double screened, screening efficiency >90dB



used as Type	inner/outer 1.0/4.6 GH-Y	Underground 1.0/4.6 GH-2Y	Safety zones 1.0/4.6 GH-FRNC
Part no.	40176	40177	40178
<b>Cable structure</b>			
Inner conductor Ø mm	1 Copper with skin	1 Copper with skin	1 Copper with skin
Insulation Ø mm	4,6 Cell polyethylene with skin and PIB coating	4,6 Cell polyethylene with skin and PIB coating	4,6 Cell polyethylene with skin and PIB coating
Outer conductor	Polyester foil coated with aluminium on both sides	Polyester foil coated with aluminium on both sides	Polyester foil coated with aluminium on both sides
Outer sheath	PVC	PE	FRNC
Sheath colour	white	black	grey
Outer Ø app. mm	6,6	6,6	6,6
Approx. bending radius app. mm	45	45	45
Weight app. kg / km	40	40	40
<b>Electrical characteristics</b>			
<b>Impedance (Ohm)</b>	<b>75 ± 1</b>	<b>75 ± 1</b>	<b>75 ± 1</b>
Capacitance pF/m	55	55	55
Propagation velocity v/c	0,8	0,85	0,85
Attenuation at 20°C (db/100m)			
100 MHz	5,8	5,8	5,8
200 MHz	7,8	7,8	7,8
450 MHz	12,5	12,5	12,5
600 MHz	14,7	14,7	14,7
800 MHz	17,2	17,2	17,2
1000 MHz	19,1	19,1	19,1
1750 MHz	26,2	26,2	26,2
2050 MHz	28,5	28,5	28,5
2400 MHz	31,3	31,3	31,3
Structural return loss min. (dB) between			
30 and 300 MHz	30	30	30
300 and 600 MHz	32	32	32
600 and 960 MHz	31	31	31
960 and 1750 MHz	26	26	26
1750 and 2400 MHz	30	30	30
<b>DC resistance at 20°C</b>			
Inner conductor max.Ohm/km	18	18	18
Outer conductor max.Ohm/km	20	20	20
Max. nominal voltage (V)	-	-	-
Screening efficiency (dB) ≥	90	90	90
Copper weight kg/km	22,0	22,0	22,0

Dimensions and specifications may be changed without prior notice. (RM01)

## Note

- The materials used in manufacture are cadmium-free and contain no silicone and free from substances harmful to the wetting properties of lacquers.
- FRNC**=Flame Retardant Non Corrosive, **PEE**= Cell-Polyethylene, **PIB**= Polyisobutylene, **ALPR**=Polyesterfoil coated with Aluminium on both sides  
**F**=Foil, **G**=Braid, **GH**=Braid-covering ca. 88%

## Application

### • Copper inner-conductor 1,02 with skin-effect

Protection against humidity and corrosion / Solid compound of dielectric. No change of position during installation in narrow bending radius.

### • Dielectric 4,6 mm Ø : - special PE-compound, foaming by GAS-INJEKTION

Important improvement of propagation velocity values / Very high transmission speed of individual signals (presumption for Multimedia) / Improvement for the resistance to ageing / Reduction of attenuation-loss by approx. 2dB

### • The over surface of dielectric consists too a skin-coating (smooth over surface)

Protection against humidity and other chemical influences / Minimum impedance tolerance ± 2 Ohm / This coaxial cable is crimpable / Installation in narrow bending radius, no kinking risk / The transmission-loss of signals are hardly measurable to the advance in years / Additionally to the skin-effect, the dielectric contains a gel-coating (special PIB-cmpound) / We therefore offer a **15 years guarantee for attenuation-loss** by installation at 20°C room-temperature

### • Screening

a) AL/PR-foil, polyesterfoil coated with aluminium on both sides or b) Copper braiding of tinned wires, **screening efficiency >90 dB**

# SAT/BK-Coaxial Cables

for digital-tv / satellite-receivers, screened

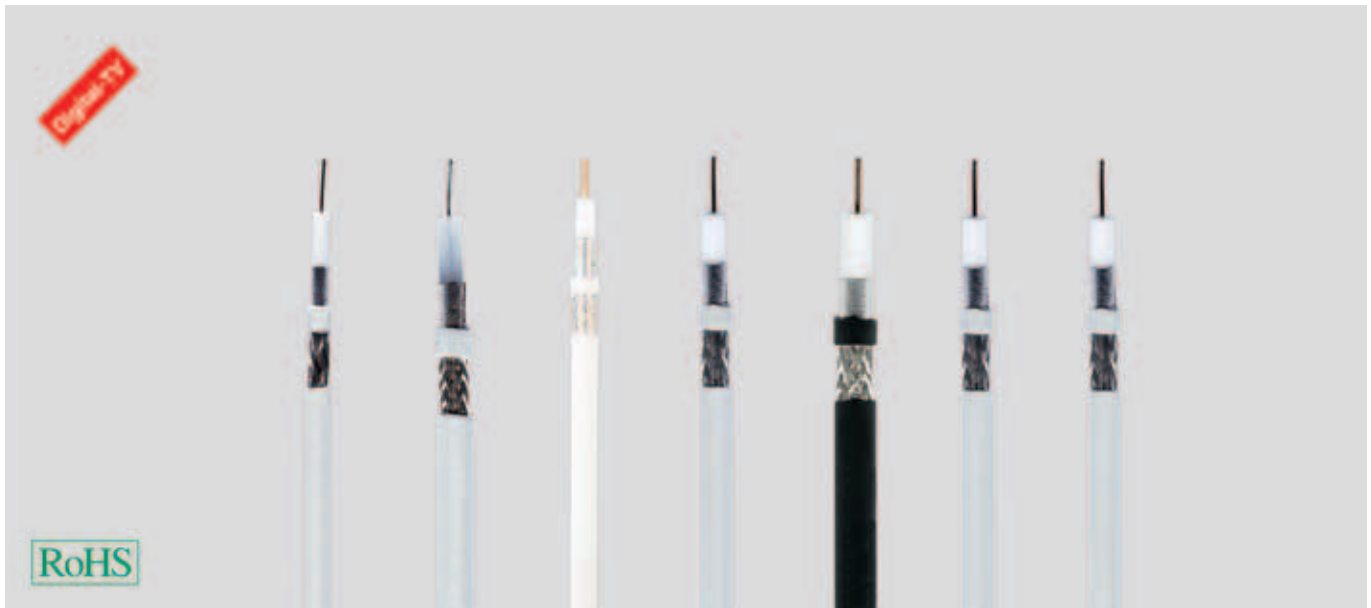

used as Type	inner 0,7/2,9	inner/outer 0,7/4,5	inner/outer 0,8/3,5	inner 1,1/5,0	Underground 1,6/7,0	inner 1,0/4,6	inner 1,0/4,6
Part no.	40015	40016	40085	40017	40018	400182	400197
<b>Cable structure</b>							
Inner conductor Ø mm	0,6	0,75	0,8	1,1	1,63	1	1
	Copper, bare	Tinned copper	Copper, bare	Copper, bare	Copper, bare	Copper, bare	Copper, bare
Insulation Ø mm	3 Polyethylene, foamed	4,5 Polyethylene, foamed	3,5 Polyethylene, foamed	4,8 Polyethylene, foamed	7,1 Polyethylene, foamed	4,6 Cell PE, foamed	4,6 Cell PE, foamed
Outer conductor	ALPR-FG	ALPR-FG	ALPR-FG	ALPR-FG	ALPR-FG	ALPR-FG	ALPR-FG
1st Screen - ALPR	foil	foil	foil	foil	foil	foil	foil
2nd Screen - Cu-Braid	Braid	Braid	Braid	Braid	Braid	Braid	Braid
Outer sheath	PVC	PVC	PVC	PVC	PE	PE	PE
Sheath colour	white	white	white	white	black	white	white
Outer Ø app. mm	4,3	6,6	5,0	6,9	10,3	6,8	6,8
Min. bending radius app. mm	43	35	50	45	60	50	50
Weight app. kg / km	20	40	32	47	110	46	48
<b>Electrical characteristics</b>							
<b>Impedance (Ohm)</b>	<b>75 ± 3</b>	<b>75 ± 3</b>	<b>75 ± 3</b>	<b>75 ± 2</b>	<b>75 ± 2</b>	<b>75 ± 3</b>	<b>75 ± 3</b>
Capacitance pF/m	55	67	53	55	55	55	55
Propagation velocity v/c	0,8	0,66	0,8	0,8	0,85	0,8	0,8
Attenuation at 20°C (db/100m)							
100 MHz	8,1	7,1	6,3	4,9	3	6,7	6,1
200 MHz	13,3	10,4	11,5	7,7	6,1	9,3	8,7
450 MHz	20,9	16,8	17,1	11,6	9	13,7	14,1
800 MHz	-	25	-	-	-	-	-
1000 MHz	31,5	27,4	26,5	18,9	14,3	22,2	20,5
1750 MHz	42,2	37,4	36,4	26,6	20,1	29,6	25,6
2050 MHz	45,8	40,5	39,7	28,2	22,5	33,3	29,4
2250 MHz	49,9	44,3	43,1	29,5	24	-	-
2400 MHz	55,5	45	-	31,9	-	36	31,9
Structural return loss min. (dB) between							
30 and 300 MHz	20	20	35	25	40	-	-
300 and 600 MHz	18	18	35	18	35	35	35
600 and 960 MHz	16	18	30	17	35	35	35
960 and 1750 MHz	-	-	30	15	30	30	30
<b>DC resistance at 20°C</b>							
Inner conductor max. Ohm/km	52	110	36	18	9	9	9
Outer conductor max. Ohm/km	29	22	28	14	21	21	21
Max. nominal voltage (V)	-	-	-	-	-	-	-
<b>Screening efficiency (dB)</b>							
50 and 100 MHz ≥	95	90	90	95	90	115	120
100 and 500 MHz ≥	95	90	90	95	90	115	120
500 and 1000 MHz ≥	95	90	90	95	90	115	120
1000 and 2050 MHz ≥	95	90	90	95	90	115	120
Copper weight kg/km	12,5	9,0	9,0	25,0	32,0	17,0	17,0

Dimensions and specifications may be changed without prior notice. (RM01)

# SAT/BK-Coaxial Cables

for digital-tv / satellite-receivers, screened, halogen-free



used as Type	inner 1,1/5,0 FRNC	inner/outer 1,1/5,0 FRNC	inner 1,6/7,0 FRNC
Part no.	40019	40021	40020
<b>Cable structure</b>			
Inner conductor Ø mm	1,1 Copper, bare	1,1 Copper, bare	1,6 Copper, bare
Insulation Ø mm	4,8 Cell PE, foamed	4,8 Cell PE, foamed	7,1 Polyethylene, foamed
Outer conductor	ALPR-FG	ALPR-FG	ALPR-FG
1st Screen - ALPR	foil	foil	foil
2nd Screen - Cu-Braid	Braid	Braid	Braid
Outer sheath	FRNC	FRNC	FRNC
Sheath colour	white	black	white
Outer Ø app. mm	6,8	6,8	10,0
Min. bending radius app. mm	48	48	60
Weight app. kg / km	47	47	110
<b>Electrical characteristics</b>			
<b>Impedance (Ohm)</b>	<b>75 ± 2</b>	<b>75 ± 2</b>	<b>75 ± 2</b>
Capacitance pF/m	53	55	53
Propagation velocity v/c	0,8	0,8	0,8
Attenuation at 20°C (db/100m)			
100 MHz	4,7	4,9	3,8
200 MHz	7	7,2	5,5
450 MHz	11,5	11,6	8,6
800 MHz	17	-	12,1
1000 MHz	18,1	18,9	13,2
1750 MHz	25	26,6	17,5
2050 MHz	27,3	28,2	19
2250 MHz	28	29,5	19,9
2400 MHz	29,3	31,9	22,5
Structural return loss min. (dB) between			
30 and 300 MHz	25	40	25
300 and 600 MHz	18	40	18
600 and 960 MHz	17	35	17
960 and 1750 MHz	15	30	15
<b>DC resistance at 20°C</b>			
Inner conductor max.Ohm/km	18	18	9
Outer conductor max. Ohm/km	14	14	21
Max. nominal voltage (V)	-	-	-
<b>Screening efficiency (dB)</b>			
50 and 100 MHz ≥	90	95	90
100 and 500 MHz ≥	90	95	90
500 and 1000 MHz ≥	90	95	90
1000 and 2050 MHz ≥	90	95	90
Copper weight kg/km	25,0	25,0	50,5

Dimensions and specifications may be changed without prior notice.



# RGB-COAX-CY / RGB-COAX-(St)Y

transmission cables for colour monitor



## Technical data

- **Base cable 0,37/1,5 or 0,6/3,7**
- **Temperature range**  
fixed installation -10°C to +80°C  
flexing -5°C to +50°C
- **Mutual capacitance** 67 nF/km
- **Impedance** 75 Ohm
- **Attenuation**  
RGB-Coax 0,37/1,5  
1 MHz = 2,0 dB/100m  
2 MHz = 2,8 dB/100m  
5 MHz = 4,0 dB/100m  
10 MHz = 5,8 dB/100m  
20 MHz = 8,4 dB/100m  
50 MHz = 13,9 dB/100m  
100 MHz = 19,8 dB/100m  
200 MHz = 28,5 dB/100m  
RGB-Coax 0,6/3,7  
1 MHz = 1,1 dB/100m  
2 MHz = 1,5 dB/100m  
5 MHz = 2,5 dB/100m  
10 MHz = 3,5 dB/100m  
20 MHz = 4,5 dB/100m  
50 MHz = 7,2 dB/100m  
100 MHz = 10,4 dB/100m  
200 MHz = 15,1 dB/100m
- **Minimum bending radius**  
15x cable Ø

## Application

RGB cables are suitable for the transmission of both analogue and digital video signals. They are used particularly as connecting cables for data systems, engineering applications (CAD, high-definition graphics) and in television studios. The three main signals (red, green, blue) are transmitted separately. Depending on the application, it is possible to supply the base cable with further coaxial cables or with symmetrical signal cores for the intensity and horizontal or vertical synchronisation.

Part no.	No. RGB-Coax n x mm	Outer Ø app. mm	Cop. weight kg / km	Weight app. kg / km
40145	3 x 0,37/1,5	7,2	23,0	59,0
40147	3 x 0,37/1,5 + 3 x 0,25	8,2	60,5	89,0
40146	5 x 0,37/1,5	9,0	36,0	89,0

Dimensions and specifications may be changed without prior notice. (RM01)

## Cable structure

### RGB-COAX-CY ... x0,37/1,5

- Inner conductor bare copper, solid, conductor Ø 0,37 mm
- Dielectric (insulation) of cell-Polyethylene
- Outer conductor of tinned copper wire braiding
- PVC-sheath in colour  
red, green, blue for 3xRGB COAX  
red, green, blue, white, black for 5xRGB COAX
- 3 or 5 Coax twisted with optimal lay-length
- Foil taping
- Overall braid-screening, tinned copper with optimal surface coverage and drain-wire
- PVC-outer sheath, black

### RGB-COAX-CY 3x0,37/1,5 + 3x0,25

- Cable structure as per above, but with 3 additional control cores (3x0,25) in the interstices, colour brown, green, white

### RGB-COAX-(St)Y ... x0,6/3,7 (deviation)

- Inner conductor, bare copper, solid, conductor Ø 0,6 mm
- Outer conductor of tinned or bare copper wire braiding
- Foil taping
- Plastic coated aluminium foil and drain wire
- Outer sheath of PVC, green or black

## Properties

- The materials used in manufacture are cadmium-free and contain no silicone and free from substances harmful to the wetting properties of lacquers.



## ■ DATA, NETWORK & BUS TECHNOLOGY

<b>Designation</b>	<b>Page</b>
Data cable 600 S-STP	60
Data cable 600 S-STP ROBUST	60
Data cable 600 A Outdoor S-STP PVC/PVC	60
Data cable 1200 S-STP	60
Data cable 600 S-STP flex	60
Data cable 200 S-FTP ROBUSTFLEX	60
Data cable 100 S S-FTP 4-CORE DRAG CHAIN Eco	60
Data cable 100 S S-FTP 4-PAIR DRAG CHAIN Eco	60
Data cable 200 S S-FTP 4-CORE DRAG CHAIN	60
Data cable 200 S S-FTP 4-PAIR DRAG CHAIN	60
Fibre optic mini breakout cable I-V(ZN)H	61
Fibre optic-breakout cable I-V(ZN)HH	61
Fibre optic-universal-mini breakout cable A/I-VQ(ZN)BH	61
Fibre optic-universal cable A/I-DQ(ZN)BH	61
Fibre optic-cable, flexible A-V(ZN)11Y11Y	61
Fibre optic mobile trailing cable A-V(ZN)11Y	61
Fibre optic-breakout cable HCS AT-VQH(ZN)B2Y	61
Fibre optic-breakout cable HCS I-V(ZN)Y11Y	61
POF/PE polymer fibre cable I-V2Y	61
POF/PA polymer fibre cable I-V4Y(ZN)11Y	61

# ■ COPPER DATA CABLES

## FOR FIXED INSTALLATION

Data cable 600 S-STP



Part no. 80810

Data cable 600 A for outdoor use S-STP PVC/PVC



Part no. 801147

Data cable 600 S-STP ROBUST



Part no. 801197

Data cable 1200 S-STP



Part no. 81699

## FOR FLEXIBLE APPLICATIONS

Data cable 600 S-STP flex



Part no. 80294

Data cable 200 S-FTP ROBUSTFLEX



Part no. 800068

## FOR USE IN DRAG CHAINS

Data cable 100 S S-FTP 4-CORE DRAG CHAIN ECO



Part no. 82838

Data cable 100 S S-FTP 4-PAIR DRAG CHAIN ECO



Part no. 82839

Data cable 200 S S-FTP 4-CORE DRAG CHAIN



Part no. 800088

Data cable 200 S S-FTP 4-PAIR DRAG CHAIN



Part no. 81155



# FIBRE OPTIC CABLES

## MULTIMODE FIBRES

Fibre optic mini breakout cable I-V(ZN)H



Part no. 80435

Fibre optic-breakout cable I-V(ZN)HH



Part no. 80743

Fibre optic-universal-mini breakout cable A/I-VQ(ZN)BH



Part no. 82804

Fibre optic-universal cable A/I-DQ(ZN)BH



Part no. 80681

Fibre optic-cable, flexible A-V(ZN)11Y11Y



Part no. 81765

Fibre optic mobile trailing cable A-V(ZN)11Y

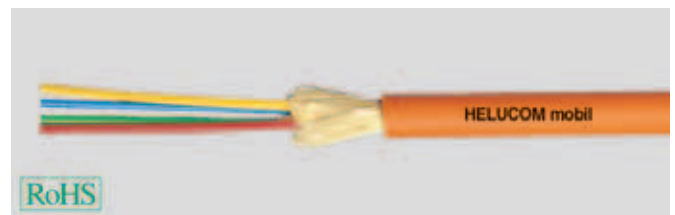

Part no. 80382

## HCS FIBRES

Fibre optic-breakout cable HCS AT-VQH(ZN)B2Y



Part no. 801196

Fibre optic-breakout cable HCS I-V(ZN)Y11Y



Art.-Nr0. 800980

## Polymer FIBRES

POF/PE polymer fibre cable I-V2Y



Part no. 80532

POF/PA polymer fibre cable I-V4Y(ZN)11Y



Part no. 801200



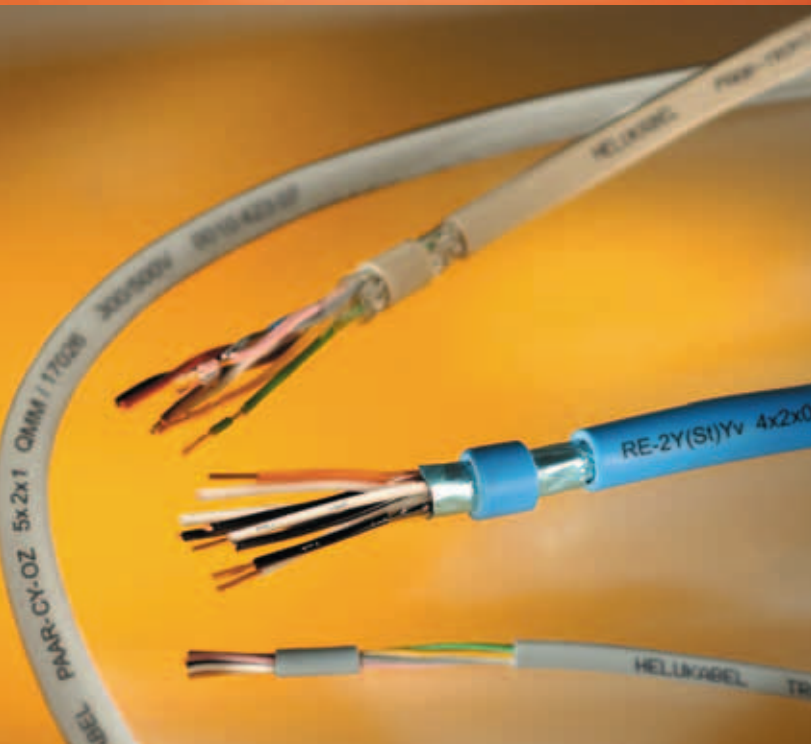

# ■ POWER CABLES

<b>Designation</b>	<b>Page</b>
JZ-500	64
F-CY-JZ	64
JZ-500 black	64
JZ-500-C black	64
JZ-500 PUR	64
F-C-PURö-JZ	64
UNIPUR®	64
UNIPUR®-CP	64
JZ-600 HMH	64
JZ-600 HMH-C	64
TRONIC-CY	65
PAAR-TRONIC-CY	65
LiYCY	65
DATAPUR-C®	65
DATAFLAMM®-C	65
DATAFLAMM®-C-PAAR	65
SUPERTRONIC®-C-PVC	65
SUPER-PAAR-TRONIC-C-PUR®	65
J-Y(ST)Y	65
J-H(ST)H	65
SiF/SiFF	66
SiF/GL, SiD, SiD/GL	66
HELUFロン®-FEP-6Y	66
HELUFロン®-PTFE-5Y	66
SiHF	66
SiHF-C-Si	66
THERMFLEX® 180 EWKF	66
THERMFLEX® EWKF-C	66
SiHF-GL/P	66
H05SS-F/H05SST-F	66
H05RR-F/H05RN-F	67
YELLOWFLEX	67
NSHTÖU	67
PVC-flat	67
TOPSERV® 108 PVC	67
TOPSERV® 109 PUR	67
NHXH-FE 180/E30	67
NHXCH-FE 180/E30	67
NHXH-FE 180/E90	67
NHXCH-FE 180/E90	67

# OVERVIEW OF POWER CABLES

## CONTROL CABLES

JZ-500

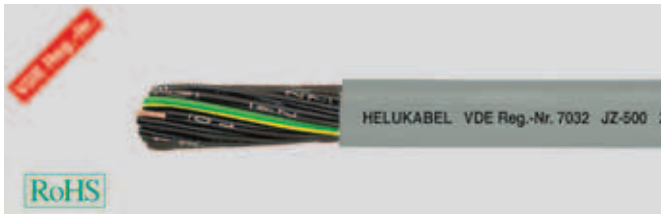

Part no. 10001

F-CY-JZ

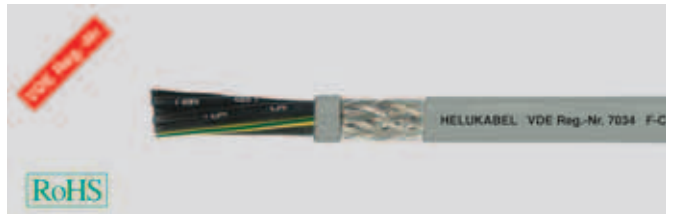

Part no. 16320

JZ-500 black



Part no. 10340

JZ-500-C black

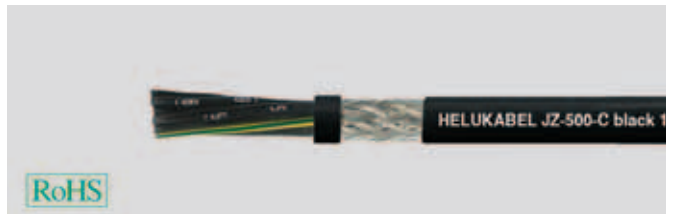

Part no. 10934

JZ-500 PUR



Part no. 23314

F-C-PURö-JZ



Part no. 21200

UNIPUR®

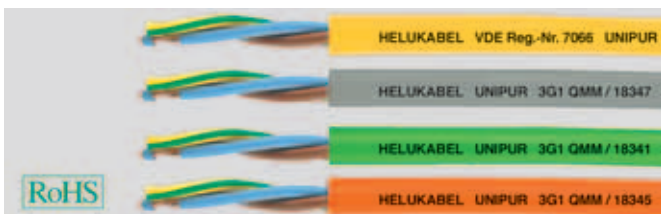

Part no. 18120

UNIPUR®-CP

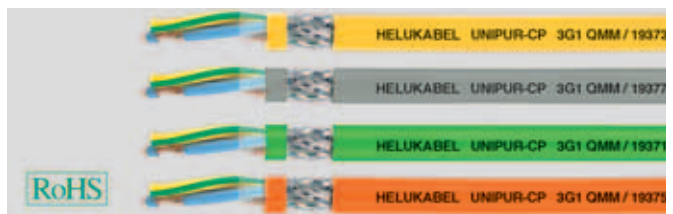

Part no. 19150

JZ-600 HMH



Part no. 12723

JZ-600 HMH-C



Part no. 12850

# DATA CABLES

TRONIC-CY

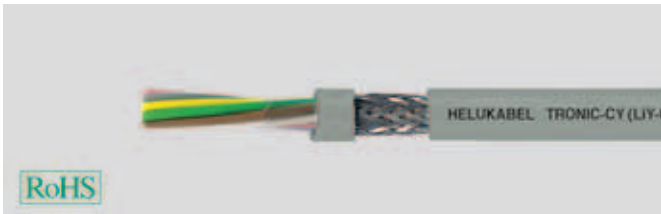

Part no. 20139

PAAR-TRONIC-CY



Part no. 21001

LifYCY

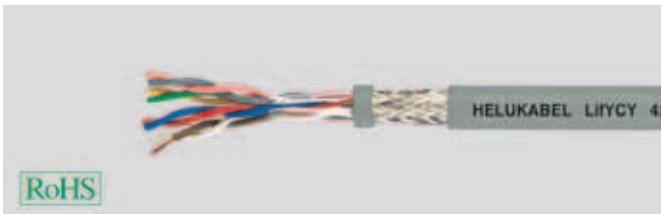

Part no. 15987

DATAPUR-C®



Part no. 52490

DATAFLAMM®-C

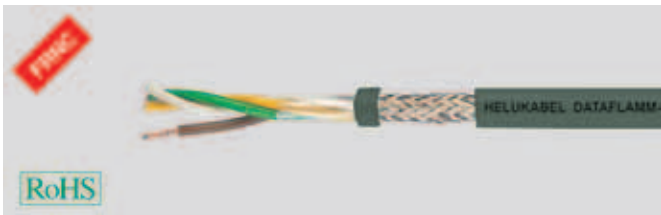

Part no. 52365

DATAFLAMM®-C-PAAR



Part no. 52435

SUPERTRONIC®-C-PVC



Part no. 49620

SUPER-PAAR-TRONIC-C-PUR®



Part no. 19101

J-Y(ST)Y



Part no. 33001

J-H(ST)H



Part no. 34050



# OVERVIEW OF POWER CABLES

## HEAT-RESISTANT CABLES

SiF/SiFF



Part no. 23200

SiF/GL, SiD, SiD/GL



Part no. 47001

HELUFLO<sup>®</sup>-FEP-6Y

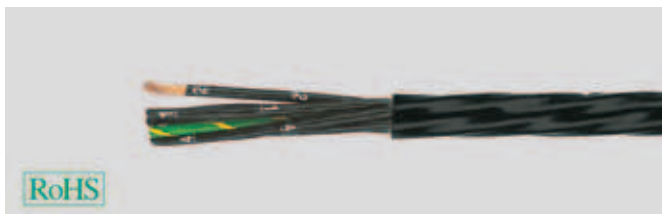

Part no. 24547

HELUFLO<sup>®</sup>-PTFE-5Y

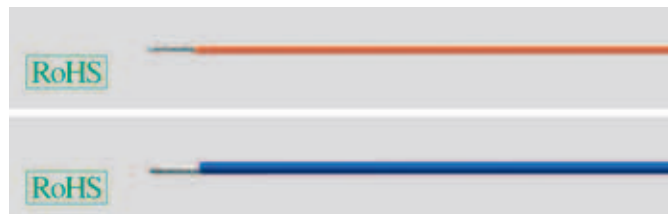

Part no. 2511x

SiHF



Part no. 22989

SiHF-C-Si



Part no. 23151

THERMFLEX<sup>®</sup> 180 EWKF



Part no. 74992

THERMFLEX<sup>®</sup> EWKF-C



Part no. 79804

SiHF-GL/P

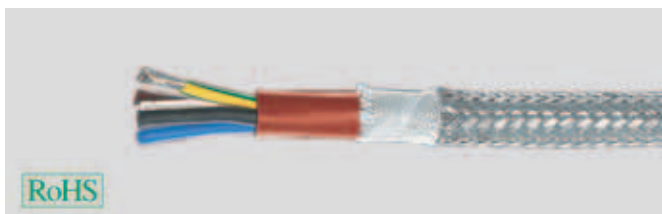

Part no. 23062

H05SS-F/H05SST-F

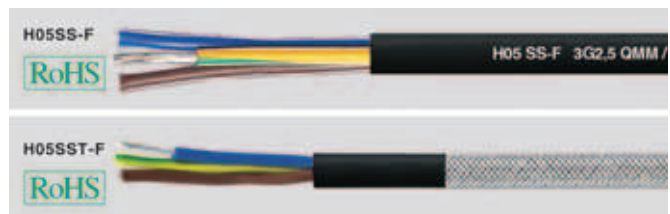

Part no. 22290

## FURTHER APPLICATION

H05RR-F/H05RN-F

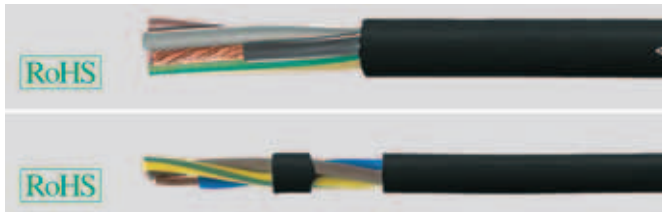

Part no. 35001

YELLOWFLEX

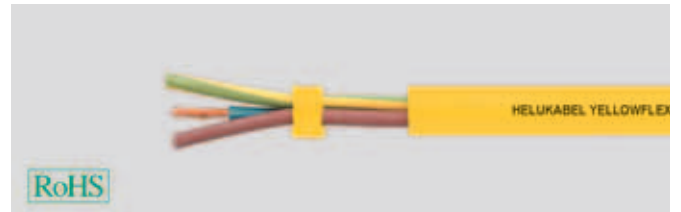

Part no. 37259

NSHTÖU



Part no. 26001

PVC-flat



Part no. 26980

TOPSERV® 108 PVC



Part no. 707250

TOPSERV® 109 PUR



Part no. 75943

NHXH-FE 180/E30



Part no. 52700

NHXCH-FE 180/E30



Part no. 52900

NHXH-FE 180/E90



Part no. 53180

NHXCH-FE 180/E90



Part no. 53032



# JZ-600

flexible, number coded, 0,6/1kV, meter marking



## Technical data

- Special PVC control cable adapted to DIN VDE 0262 and DIN VDE 0285-525-2-51 / DIN EN 50525-2-51, with insulation wall thickness for 1 kV
- **Temperature range**  
flexing -15°C to +80°C  
fixed installation -40°C to +80°C
- **Nominal voltage** U<sub>0</sub>/U 0,6/1 kV
- **Test voltage** 4000 V
- **Breakdown voltage** min. 8000 V
- **Insulation resistance**  
min. 20 MOhm x km
- **Minimum bending radius**  
flexing 7,5x cable Ø  
fixed installation 4x cable Ø
- **Radiation resistance**  
up to 80x10<sup>6</sup> cJ/kg (up to 80 Mrad)

## Cable structure

- Bare copper-conductor, to DIN VDE 0295 cl.5, fine-wire, BS 6360 cl.5, IEC 60228 cl.5
- Core insulation of special PVC compound type T12 to DIN VDE 0207-363-3 / DIN EN 50363-3
- Core identification to DIN VDE 0293 black cores with continuous white numbering
- GN-YE conductor, 3 cores and above in the outer layer
- Cores stranded in layers with optimal lay-length
- Outer sheath of special PVC compound type TM2 to DIN VDE 0207-363-4-1 / DIN EN 50363-4-1
- Sheath colour black (RAL 9005)
- with meter marking

## Properties

- Extensively oil resistant, oil-/chemical resistance see table Technical Informations
  - The materials used in manufacture are cadmium-free and contain no silicone and free from substances harmful to the wetting properties of lacquers
  - **UV-resistant**
- ### Tests
- PVC self-extinguishing and flame retardant acc. to DIN VDE 0482-332-1-2, DIN EN 60332-1-2, IEC 60332-1 (equivalent DIN VDE 0472 part 804 test method B)

## Note

- G = with green-yellow conductor  
x = without green-yellow conductor (OZ)
- AWG sizes are approximate equivalent values. The actual cross-section is in mm<sup>2</sup>.
- screened analogue type:  
**JZ-600-Y-CY**

## Application

Wiring cable for measuring and controlling purposes in tool machinery, conveyor belts and production lines, for plant installations, air conditioning and in steel production plants and rolling mills. Suitable for installation for flexible use for medium mechanical stresses with free movement without tensile stress or forced movements in dry, moist and wet rooms as well as outside (fixed installation). Is not suitable to be used as direct burial (suitable from an outer diameter of 18,0 mm for direct burial) or as underwater cable. The cores have been numbered in such a way that the numbers are easily identifiable, even if the cable has only been stripped back a few cm. The core numbers have been underlined to avoid confusion. The earth core is located in the outer layer. The black, special PVC outer sheath is resistant to the ultra violet radiation. Mainly used in South-European, Eastern and Arabian countries.

CE= The product is conformed with the EC Low-Voltage Directive 2006/95/EC.

Part no.	No. cores x cross-sec. mm <sup>2</sup>	Outer Ø app. mm	Cop. weight kg / km	Weight app. kg / km	AWG-No.
10550	2 x 0,5	6,3	9,6	56,0	20
10551	3 G 0,5	6,6	14,4	68,0	20
10552	3 x 0,5	6,6	14,4	68,0	20
10553	4 G 0,5	7,2	19,0	100,0	20
10554	4 x 0,5	7,2	19,0	100,0	20
10555	5 G 0,5	8,0	24,0	117,0	20
10556	5 x 0,5	8,0	24,0	117,0	20
10557	6 G 0,5	8,7	29,0	126,0	20
10558	7 G 0,5	8,7	33,6	138,0	20
10559	7 x 0,5	8,7	33,6	138,0	20
10560	8 G 0,5	9,5	38,0	150,0	20
10561	8 x 0,5	9,5	38,0	150,0	20
10562	10 G 0,5	10,3	48,0	176,0	20
10563	12 G 0,5	11,2	58,0	200,0	20
10564	12 x 0,5	11,2	58,0	200,0	20
10565	14 G 0,5	12,3	67,0	230,0	20
10566	16 G 0,5	12,9	76,0	250,0	20
10567	18 G 0,5	13,8	86,0	276,0	20
10568	20 G 0,5	14,4	96,0	293,0	20
10569	21 G 0,5	14,4	96,0	305,0	20
10570	25 G 0,5	16,1	120,0	335,0	20
10571	30 G 0,5	17,2	144,0	348,0	20
10572	32 G 0,5	18,0	154,0	355,0	20
10573	34 G 0,5	18,7	163,0	520,0	20
10574	40 G 0,5	19,5	192,0	590,0	20
10575	42 G 0,5	20,1	202,0	595,0	20
10576	50 G 0,5	22,1	240,0	715,0	20
10577	52 G 0,5	22,1	252,0	740,0	20
10578	61 G 0,5	23,6	293,0	840,0	20
10579	65 G 0,5	24,4	312,0	880,0	20
10580	80 G 0,5	27,2	384,0	960,0	20
10581	100 G 0,5	31,2	480,0	1050,0	20

Part no.	No. cores x cross-sec. mm <sup>2</sup>	Outer Ø app. mm	Cop. weight kg / km	Weight app. kg / km	AWG-No.
10582	2 x 0,75	6,6	14,4	66,0	19
10583	3 G 0,75	6,9	21,6	74,0	19
10584	3 x 0,75	6,9	21,6	74,0	19
10585	4 G 0,75	7,5	29,0	126,0	19
10586	4 x 0,75	7,5	29,0	126,0	19
10587	5 G 0,75	8,4	36,0	140,0	19
10588	5 x 0,75	8,4	36,0	140,0	19
10589	6 G 0,75	9,3	43,0	170,0	19
10590	6 x 0,75	9,3	43,0	170,0	19
10591	7 G 0,75	9,3	50,0	190,0	19
10592	7 x 0,75	9,3	50,0	190,0	19
10593	8 G 0,75	10,3	58,0	212,0	19
10594	8 x 0,75	10,3	58,0	212,0	19
10595	9 G 0,75	11,0	65,0	227,0	19
10596	10 G 0,75	11,0	72,0	238,0	19
10597	12 G 0,75	12,0	86,0	257,0	19
10598	12 x 0,75	12,0	86,0	257,0	19
10599	14 G 0,75	12,9	101,0	286,0	19
10600	15 G 0,75	13,8	108,0	319,0	19
10601	18 G 0,75	14,5	130,0	362,0	19
10602	20 G 0,75	15,4	144,0	394,0	19
10603	21 G 0,75	15,4	151,0	422,0	19
10604	25 G 0,75	17,2	180,0	486,0	19
10605	32 G 0,75	19,0	230,0	595,0	19
10606	34 G 0,75	19,9	245,0	638,0	19
10607	37 G 0,75	19,9	260,0	696,0	19
10608	40 G 0,75	20,7	288,0	726,0	19
10609	41 G 0,75	21,6	296,0	750,0	19
10610	42 G 0,75	21,6	302,0	770,0	19
10611	50 G 0,75	23,7	360,0	895,0	19
10612	61 G 0,75	25,3	439,0	1070,0	19
10613	65 G 0,75	26,3	468,0	1110,0	19
10614	80 G 0,75	28,9	576,0	1500,0	19
10615	100 G 0,75	32,2	720,0	1889,0	19

Continuation ▶

# JZ-600

flexible, number coded, 0,6/1kV, meter marking



Part no.	No.cores x cross-sec. mm <sup>2</sup>	Outer Ø app. mm	Cop. weight kg / km	Weight app. kg / km	AWG-No.
10616	2 x 1	7,0	19,2	80,0	18
10617	3 G 1	7,4	29,0	96,0	18
10618	3 x 1	7,4	29,0	96,0	18
10619	4 G 1	8,2	38,4	100,0	18
10620	4 x 1	8,2	38,4	100,0	18
10621	5 G 1	9,2	48,0	130,0	18
10622	5 x 1	9,2	48,0	130,0	18
10623	6 G 1	9,9	58,0	150,0	18
10624	7 G 1	9,9	67,0	170,0	18
10625	7 x 1	9,9	67,0	170,0	18
10626	8 G 1	10,9	77,0	230,0	18
10627	9 G 1	11,9	86,0	250,0	18
10628	10 G 1	11,9	96,0	270,0	18
10629	10 x 1	11,9	96,0	270,0	18
10630	12 G 1	12,8	115,0	290,0	18
10631	12 x 1	12,8	115,0	290,0	18
10632	14 G 1	14,0	134,0	320,0	18
10633	16 G 1	14,8	154,0	360,0	18
10634	18 G 1	15,7	173,0	405,0	18
10635	18 x 1	15,7	173,0	405,0	18
10636	20 G 1	16,7	192,0	450,0	18
10637	20 x 1	16,7	192,0	480,0	18
10638	21 G 1	16,7	205,0	510,0	18
10639	24 G 1	18,4	236,0	550,0	18
10640	25 G 1	18,6	240,0	570,0	18
10641	25 x 1	18,6	240,0	570,0	18
10642	26 G 1	18,8	252,0	590,0	18
10643	30 x 1	19,8	308,0	650,0	18
10644	34 G 1	21,5	326,0	750,0	18
10645	36 G 1	21,5	346,0	790,0	18
10646	40 G 1	22,5	384,0	850,0	18
10647	40 x 1	22,5	384,0	850,0	18
10648	41 G 1	23,3	394,0	890,0	18
10649	42 G 1	23,3	403,0	900,0	18
10650	50 G 1	25,6	480,0	1100,0	18
10651	56 G 1	26,4	538,0	1190,0	18
10652	61 G 1	27,3	586,0	1266,0	18
10653	65 G 1	28,3	628,0	1560,0	18
10654	80 G 1	31,4	786,0	1810,0	18
10655	100 G 1	35,0	960,0	1950,0	18
10656	2 x 1,5	8,2	29,0	95,0	16
10657	3 G 1,5	8,6	43,0	112,0	16
10658	3 x 1,5	8,6	43,0	112,0	16
10659	4 G 1,5	9,6	58,0	139,0	16
10660	4 x 1,5	9,6	58,0	139,0	16
10661	5 G 1,5	10,7	72,0	170,0	16
10662	5 x 1,5	10,7	72,0	170,0	16
10663	6 G 1,5	11,6	86,0	190,0	16
10664	7 G 1,5	11,6	101,0	225,0	16
10665	7 x 1,5	11,6	101,0	225,0	16
10666	8 G 1,5	12,9	115,0	250,0	16
10667	9 G 1,5	13,9	130,0	280,0	16
10668	10 G 1,5	13,9	144,0	300,0	16
10669	11 G 1,5	14,8	158,0	330,0	16
10670	12 G 1,5	15,0	173,0	370,0	16
10671	12 x 1,5	15,5	173,0	370,0	16
10672	14 G 1,5	16,6	202,0	400,0	16
10673	16 G 1,5	17,5	230,0	450,0	16
10674	18 G 1,5	18,6	259,0	520,0	16
10675	19 G 1,5	18,6	279,0	550,0	16
10676	20 G 1,5	19,7	288,0	600,0	16
10677	21 G 1,5	19,7	302,0	600,0	16
10678	25 G 1,5	22,5	360,0	730,0	16
10679	32 G 1,5	24,3	461,0	880,0	16
10680	34 G 1,5	25,3	490,0	950,0	16
10681	40 G 1,5	26,6	576,0	990,0	16
10682	42 G 1,5	27,4	605,0	1120,0	16
10683	50 G 1,5	30,2	720,0	1400,0	16
10684	56 G 1,5	31,2	806,0	1530,0	16
10685	61 G 1,5	32,2	878,0	1700,0	16
10686	65 G 1,5	33,5	936,0	1900,0	16
10687	80 G 1,5	36,9	1152,0	2300,0	16
10688	100 G 1,5	41,3	1440,0	2700,0	16
10689	2 x 2,5	9,6	48,0	160,0	14

Part no.	No.cores x cross-sec. mm <sup>2</sup>	Outer Ø app. mm	Cop. weight kg / km	Weight app. kg / km	AWG-No.
10690	3 G 2,5	10,1	72,0	175,0	14
10691	3 x 2,5	10,1	72,0	175,0	14
10692	4 G 2,5	11,2	96,0	203,0	14
10693	4 x 2,5	11,2	96,0	203,0	14
10694	5 G 2,5	12,5	120,0	251,0	14
10695	5 x 2,5	12,5	120,0	251,0	14
10696	7 G 2,5	13,8	168,0	330,0	14
10697	7 x 2,5	13,8	168,0	330,0	14
10698	8 G 2,5	15,1	192,0	400,0	14
10699	12 G 2,5	18,3	288,0	553,0	14
10700	14 G 2,5	19,6	336,0	630,0	14
10701	18 G 2,5	22,0	432,0	795,0	14
10702	21 G 2,5	23,3	504,0	930,0	14
10703	25 G 2,5	26,2	600,0	1110,0	14
10704	34 G 2,5	30,4	816,0	1450,0	14
10705	42 G 2,5	33,0	1008,0	1750,0	14
10706	50 G 2,5	36,2	1200,0	2100,0	14
10707	61 G 2,5	38,8	1464,0	2540,0	14
10708	100 G 2,5	49,8	2400,0	3850,0	14
10709	2 x 4	11,0	77,0	180,0	12
10710	3 G 4	11,7	115,0	230,0	12
10711	4 G 4	12,9	154,0	310,0	12
10712	5 G 4	14,4	192,0	410,0	12
10713	7 G 4	15,8	269,0	540,0	12
10714	8 G 4	17,5	307,0	710,0	12
10715	12 G 4	21,0	461,0	860,0	12
10716	3 G 6	13,1	173,0	370,0	10
10717	4 G 6	14,5	230,0	430,0	10
10718	5 G 6	16,2	288,0	650,0	10
10719	7 G 6	18,0	403,0	860,0	10
10720	3 G 10	16,8	288,0	660,0	8
10721	4 G 10	18,5	384,0	790,0	8
10722	5 G 10	20,5	480,0	960,0	8
10723	7 G 10	22,5	672,0	1300,0	8
10724	3 G 16	20,2	461,0	700,0	6
10725	4 G 16	22,4	614,0	1100,0	6
10726	5 G 16	25,0	768,0	1600,0	6
10727	7 G 16	27,4	1075,0	1890,0	6
10728	3 G 25	24,8	720,0	1450,0	4
10729	4 G 25	27,4	960,0	1600,0	4
10730	5 G 25	30,5	1200,0	2050,0	4
10731	7 G 25	33,8	1680,0	2900,0	4
10732	3 G 35	27,4	1008,0	1900,0	2
10733	4 G 35	30,3	1344,0	2400,0	2
10734	5 G 35	33,6	1680,0	2900,0	2
10735	3 G 50	32,4	1440,0	2700,0	1
10736	4 G 50	35,8	1920,0	3400,0	1
10742	5 G 50	40,0	2400,0	4361,0	1
10737	3 G 70	36,8	2016,0	3300,0	2/0
10738	4 G 70	40,8	2688,0	4400,0	2/0
10743	5 G 70	45,2	3360,0	5807,0	2/0
10739	3 G 95	41,7	2736,0	5050,0	3/0
10740	4 G 95	46,2	3648,0	6010,0	3/0
10744	5 G 95	51,7	4560,0	7752,0	3/0
10741	4 G 120	51,6	4608,0	7500,0	4/0
10745	4 G 150	58,5	5760,0	8640,0	300 kcmil
10746	4 G 185	63,3	7104,0	10380,0	350 kcmil

Dimensions and specifications may be changed without prior notice. (RA01)

# JZ-600-Y-CY

flexible, number coded, 0,6/1kV, Cu screened meter marking, EMC-preferred type



## Technical data

- Adapted to DIN VDE 0262 and DIN VDE 0285-525-2-51 / DIN EN 50525-2-51
- Temperature range**  
flexing -15°C to +80°C  
fixed installation -40°C to +80°C
- Nominal voltage**  $U_0/U$  0,6/1 kV
- Test voltage** 4000 V
- Breakdown voltage** min. 8000 V
- Insulation resistance**  
min. 20 MOhm x km
- Coupling resistance**  
max. 250 Ohm/km
- Minimum bending radius**  
flexing 10x cable Ø  
fixed installation 5x cable Ø
- Radiation resistance**  
up to  $80 \times 10^6$  cJ/kg (up to 80 Mrad)

## Cable structure

- Bare copper-conductor, to DIN VDE 0295 cl.5, fine-wire, BS 6360 cl.5, IEC 60228 cl.5
- Core insulation of Special PVC compound type T12 to DIN VDE 0207-363-3 / DIN EN 50363-3
- Core identification to DIN VDE 0293 black cores with continuous white numbering
- GN-YE conductor, 3 cores and above in the outer layer
- Cores stranded in layers with optimal lay-length
- Inner sheath of PVC
- Tinned copper braided screen, approx. 85% coverage
- Outer sheath of special PVC compound type TM2 to DIN VDE 0207-363-4-1 / DIN EN 50363-4-1
- Sheath colour black (RAL 9005)
- with meter marking

## Properties

- Extensively oil resistant, oil-/chemical resistance see table Technical Informations
  - The materials used in manufacture are cadmium-free and contain no silicone and free from substances harmful to the wetting properties of lacquers
  - UV resistant**
- ### Tests
- PVC self-extinguishing and flame retardant acc. to DIN VDE 0482-332-1-2, DIN EN 60332-1-2, IEC 60332-1 (equivalent DIN VDE 0472 part 804 test method B)

## Note

- G = with green-yellow conductor  
x = without green-yellow conductor (OZ)
- Further sizes are available on request.
- AWG sizes are approximate equivalent values. The actual cross-section is in mm<sup>2</sup>.
- unscreened analogue type:  
**JZ-600**

## Application

Wiring cable for measuring and controlling purposes in tool machinery, conveyor belts and production lines, for plant installations, air conditioning and in steel production plants and rolling mills. Suitable for installation for flexible use for medium mechanical stresses with free movement without tensile stress or forced movements in dry, moist and wet rooms as well as outside (fixed installation). Is not suitable to be used as direct burial- or as underwater cable. The cores have been numbered in such a way that the numbers are easily identifiable, even if the cable has only been stripped back a few cm. The core numbers have been underlined to avoid confusion. The earth core is located in the outer layer. The black, special PVC outer sheath is resistant to the ultra violet radiation. Mainly used in South-European, Eastern and Arabian countries. Interference-free transmission of signals and pulses is assured by the high degree of screening.

**EMC** = Electromagnetic compatibility

To optimize the EMC features we recommend a large round contact of the copper braiding on both ends.

**CE** = The product is conformed with the EC Low-Voltage Directive 2006/95/EC.

Part no.	No. cores x cross-sec. mm <sup>2</sup>	Outer Ø app. mm	Cop. weight kg / km	Weight app. kg / km	AWG-No.
11464	2 x 0,5	8,5	41,0	129,0	20
11465	3 G 0,5	8,8	45,0	150,0	20
11466	4 G 0,5	9,4	54,0	170,0	20
11467	5 G 0,5	10,2	66,0	199,0	20
11469	7 G 0,5	10,8	79,0	235,0	20
11472	12 G 0,5	14,3	137,0	320,0	20
11475	18 G 0,5	16,4	156,0	428,0	20
11478	25 G 0,5	19,3	250,0	503,0	20
11489	2 x 0,75	8,8	46,0	143,0	19
11490	3 G 0,75	9,1	57,0	155,0	19
11491	4 G 0,75	9,9	63,0	190,0	19
11492	5 G 0,75	10,6	76,0	228,0	19
11494	7 G 0,75	11,5	100,0	323,0	19
11498	12 G 0,75	15,0	175,0	410,0	19
11501	18 G 0,75	17,2	240,0	560,0	19
11504	25 G 0,75	20,6	306,0	730,0	19

Part no.	No. cores x cross-sec. mm <sup>2</sup>	Outer Ø app. mm	Cop. weight kg / km	Weight app. kg / km	AWG-No.
11516	2 x 1	9,2	54,0	150,0	18
11517	3 G 1	9,8	64,0	163,0	18
11518	4 G 1	10,4	76,0	200,0	18
11519	5 G 1	11,4	89,0	239,0	18
11521	7 G 1	12,3	114,0	289,0	18
11525	12 G 1	15,9	186,0	464,0	18
11528	18 G 1	18,2	284,0	628,0	18
11532	25 G 1	22,0	387,0	855,0	18
11546	2 x 1,5	10,4	64,0	162,0	16
11547	3 G 1,5	10,8	82,0	187,0	16
11548	4 G 1,5	11,5	99,0	240,0	16
11549	5 G 1,5	13,0	123,0	289,0	16
11551	7 G 1,5	14,2	148,0	383,0	16
11556	12 G 1,5	18,4	274,0	592,0	16
11559	18 G 1,5	21,3	386,0	806,0	16
11563	25 G 1,5	25,4	531,0	1241,0	16

Continuation ▶

# JZ-600-Y-CY

flexible, number coded, 0,6/1kV, Cu screened meter marking, EMC-preferred type



Part no.	No.cores x cross-sec. mm <sup>2</sup>	Outer Ø app. mm	Cop. weight kg / km	Weight app. kg / km	AWG-No.	Part no.	No.cores x cross-sec. mm <sup>2</sup>	Outer Ø app. mm	Cop. weight kg / km	Weight app. kg / km	AWG-No.
11574	2 x 2,5	11,8	110,0	272,0	14	11608	3 G 16	23,4	653,0	1395,0	6
11575	3 G 2,5	12,8	148,0	298,0	14	11609	4 G 16	25,7	807,0	1870,0	6
11576	4 G 2,5	13,8	169,0	345,0	14	11610	5 G 16	28,5	940,0	2720,0	6
11577	5 G 2,5	15,0	220,0	427,0	14	11611	7 G 16	31,4	1345,0	3213,0	6
11578	7 G 2,5	16,3	284,0	561,0	14	11612	3 G 25	28,2	920,0	2465,0	4
11580	12 G 2,5	21,6	470,0	857,0	14	11613	4 G 25	31,3	1169,0	2750,0	4
11582	18 G 2,5	25,2	572,0	1355,0	14	11614	5 G 25	34,5	1420,0	3490,0	4
11584	25 G 2,5	30,0	740,0	1995,0	14	11615	7 G 25	37,8	1921,0	4980,0	4
11590	2 x 4	13,6	124,0	306,0	12	11616	3 G 35	31,2	1250,0	3230,0	2
11591	3 G 4	14,6	178,0	391,0	12	11617	4 G 35	34,5	1680,0	4100,0	2
11592	4 G 4	15,7	234,0	527,0	12	11618	5 G 35	38,0	2020,0	4950,0	2
11593	5 G 4	17,2	284,0	700,0	12	11619	3 G 50	36,5	1887,0	4590,0	1
11594	7 G 4	18,9	321,0	920,0	12	11620	4 G 50	40,5	2370,0	5780,0	1
11596	12 G 4	24,5	581,0	1510,0	12	11621	5 G 50	45,2	2880,0	7210,0	1
11597	2 x 6	14,9	176,0	420,0	10	11622	3 G 70	41,8	2516,0	5610,0	2/0
11598	3 G 6	15,9	245,0	629,0	10	11623	4 G 70	46,0	3257,0	7480,0	2/0
11599	4 G 6	17,4	316,0	731,0	10	11624	5 G 70	50,4	4032,0	9390,0	2/0
11600	5 G 6	19,2	442,0	1105,0	10	11625	3 G 95	46,8	3086,0	8585,0	3/0
11601	7 G 6	20,9	530,0	1465,0	10	11626	4 G 95	51,3	4060,0	10220,0	3/0
11602	2 x 10	18,6	260,0	845,0	8	11627	5 G 95	56,1	5244,0	13800,0	3/0
11603	3 G 10	19,8	367,0	1125,0	8	11628	3 G 120	51,8	4176,0	11105,0	4/0
11604	4 G 10	21,5	549,0	1345,0	8	11629	4 G 120	56,3	5231,0	13750,0	4/0
11605	5 G 10	23,5	604,0	1635,0	8	13137	4 G 150	64,4	7760,0	15990,0	300 kcmil
11606	7 G 10	25,6	820,0	2210,0	8	13147	4 G 185	69,5	8104,0	18470,0	350 kcmil
11607	2 x 16	21,8	491,0	1150,0	6						

Dimensions and specifications may be changed without prior notice. (RA01)

# H07RN-F

rubber-sheathed cable, harmonized type



## Technical data

- Rubber sheathed cable H07RN-F to DIN VDE 0285-525-2-21, BS 7919 DIN EN 50525-2-21, IEC 60245-4
- **Temperature range**  
-30°C to +60°C
- Permissible **operating temperature** at conductor +60°C
- **Nominal voltage**  
U<sub>0</sub>/U 450/750 V  
in case of protected and fixed installation  
U<sub>0</sub>/U 600/1000 V
- Max. permissible **operating voltage** in three phase and one phase a.c. system  
U<sub>0</sub>/U 476/825 V  
direct current-system  
U<sub>0</sub>/U 619/1238 V
- **Test voltage** 2500 V
- **Permanent tensile load**  
max. 15 N/mm<sup>2</sup>
- **Minimum bending radius**  
for fixed installation 4x cable Ø  
for guiding over roller 7,5x cable Ø  
during winding on drums 5x cable Ø

## Cable structure

- Bare copper-conductor, to DIN VDE 0295 cl.5, fine-wire, BS 6360 cl.5, IEC 60228 cl.5
- Core insulation of rubber EI4 to DIN VDE 0207-363-1 / DIN EN 50363-1
- Core identification to DIN VDE 0293-308  
- up to 5 cores coloured  
- from 6 cores, black with continuous white numbering
- GN-YE conductor, 3 cores and above
- Cores stranded in layers with optimal lay-length
- Outer sheath of rubber EM2 to DIN VDE 0207-363-2-1 / DIN EN 50363-2-1
- Sheath colour black

## Properties

### Resistant to

- Weather

### Tests

#### • Behaviour in fire

to DIN VDE 0482-332-1-2  
DIN EN 60332-2-1, IEC 60332-1 (equivalent DIN VDE 0472 part 804 test method B)

- **Ozone resistant** of the insulation to DIN VDE 0472 part 805, test method A or part 805 A1, test method C

- **Oil resistant** test according to DIN VDE 0473-811-404, DIN EN 60811-404

## Note

- G = with green-yellow conductor  
x = without green-yellow conductor
- AWG sizes are approximate equivalent values. The actual cross-section is in mm<sup>2</sup>.
- The core identification of a single core sheathed, of an insulated wire is black.

## Application

Heavy duty rubber-sheathed flexible cables are suited for use for medium mechanical stress in dry, damp and wet areas as well as in open air and in agriculture plants. They are used for equipment in industry works such as boilers, heating plates, hand lamps, electric tools such as drills, circular saws and homework tools as well as for transportable motors or machines at site. These cables are also suitable for fixed installation on plaster, in temporary buildings and residential barracks. They are suitable for direct laying on components and mechanical parts of machines, for example lifts and cranes. They can be used in case of protected and fixed installation in tubes or in equipment as well as rotor connecting cable of motors with a working voltage up to 1000 V alternating voltage or a direct voltage up to 750 V against ground. The operating direct voltage is permitted up to 900 V against ground when they are used in rail-coaches. Installation in hazardous areas according to DIN VDE 0165 is allowed.

CE= The product is conformed with the EC Low-Voltage Directive 2006/95/EC.

Part no.	No. cores x cross-sec. mm <sup>2</sup>	Outer Ø min. - max. mm	Cop. weight kg / km	Weight app. kg / km	AWG-No.
37001	1 x 1,5	5,7 - 7,1	14,4	58,0	16
37002	1 x 2,5	6,3 - 7,9	24,0	71,0	14
37003	1 x 4	7,2 - 9,0	38,0	100,0	12
37004	1 x 6	7,9 - 9,8	58,0	130,0	10
37005	1 x 10	9,5 - 11,9	96,0	230,0	8
37006	1 x 16	10,8 - 13,4	154,0	290,0	6
37007	1 x 25	12,7 - 15,8	240,0	420,0	4
37008	1 x 35	14,3 - 17,9	336,0	530,0	2
37009	1 x 50	16,5 - 20,6	480,0	750,0	1
37010	1 x 70	18,6 - 23,3	672,0	960,0	2/0
37011	1 x 95	20,8 - 26,0	912,0	1250,0	3/0
37012	1 x 120	22,8 - 28,6	1152,0	1560,0	4/0
37013	1 x 150	25,2 - 31,4	1440,0	1900,0	300 kcmil
37014	1 x 185	27,6 - 34,4	1776,0	2300,0	350 kcmil
37015	1 x 240	30,6 - 38,3	2304,0	2950,0	500 kcmil
37016	1 x 300	33,5 - 41,9	2880,0	3600,0	600 kcmil
37017	1 x 400	37,4 - 46,8	3840,0	4600,0	750 kcmil
37018	1 x 500	41,3 - 52,0	4800,0	6000,0	1000 kcmil
37019	2 x 1	7,7 - 10,0	19,0	98,0	18
37020	2 x 1,5	8,5 - 11,0	29,0	135,0	16

Part no.	No. cores x cross-sec. mm <sup>2</sup>	Outer Ø min. - max. mm	Cop. weight kg / km	Weight app. kg / km	AWG-No.
37021	2 x 2,5	10,2 - 13,1	48,0	193,0	14
37022	2 x 4	11,8 - 15,1	77,0	280,0	12
37023	2 x 6	13,1 - 16,8	115,0	330,0	10
37024	2 x 10	17,7 - 22,6	192,0	586,0	8
37025	2 x 16	20,2 - 25,7	307,0	810,0	6
37026	2 x 25	24,3 - 30,7	480,0	1160,0	4
37027	3 G 1	8,3 - 10,7	29,0	130,0	18
37028	3 G 1,5	9,2 - 11,9	43,0	165,0	16

Continuation ▶

# H07RN-F

rubber-sheathed cable, harmonized type



Part no.	No. cores x cross-sec. mm <sup>2</sup>	Outer Ø min. - max. mm	Cop. weight kg / km	Weight app. kg / km	AWG-No.
37029	3 G 2,5	10,9 - 14,0	72,0	235,0	14
37030	3 G 4	12,7 - 16,2	115,0	320,0	12
37031	3 G 6	14,1 - 18,0	173,0	420,0	10
37032	3 G 10	19,1 - 24,2	288,0	810,0	8
37033	3 G 16	21,8 - 27,6	461,0	1050,0	6
37034	3 G 25	26,1 - 33,0	720,0	1250,0	4
37035	3 G 35	29,3 - 37,1	1008,0	1900,0	2
37036	3 G 50	34,1 - 42,9	1440,0	2600,0	1
37037	3 G 70	38,4 - 48,3	2016,0	3400,0	2/0
37038	3 G 95	43,3 - 54,0	2736,0	4450,0	3/0
37039	3 G 120	47,4 - 60,0	3456,0	5180,0	4/0
37040	3 G 150	52,0 - 66,0	4320,0	6500,0	300 kcmil
37041	3 G 185	57,0 - 72,0	5328,0	7860,0	350 kcmil
37042	3 G 240	65,0 - 82,0	6912,0	10224,0	500 kcmil
37043	3 G 300	72,0 - 90,0	8640,0	12620,0	600 kcmil
37044	4 G 1	9,2 - 11,9	38,0	150,0	18
37045	4 G 1,5	10,2 - 13,1	58,0	200,0	16
37046	4 G 2,5	12,1 - 15,5	96,0	290,0	14
37047	4 G 4	14,0 - 17,9	154,0	395,0	12
37048	4 G 6	15,7 - 20,0	230,0	540,0	10
37049	4 G 10	20,9 - 26,5	384,0	950,0	8
37050	4 G 16	23,8 - 30,1	614,0	1260,0	6
37051	4 G 25	28,9 - 36,6	960,0	1860,0	4
37052	4 G 35	32,5 - 41,1	1344,0	2380,0	2
37053	4 G 50	37,7 - 47,5	1920,0	3190,0	1
37054	4 G 70	42,7 - 54,0	2688,0	4260,0	2/0
37055	4 G 95	48,4 - 61,0	3648,0	5600,0	3/0

Part no.	No. cores x cross-sec. mm <sup>2</sup>	Outer Ø min. - max. mm	Cop. weight kg / km	Weight app. kg / km	AWG-No.
37056	4 G 120	53,0 - 66,0	4608,0	6830,0	4/0
37057	4 G 150	58,0 - 73,0	5760,0	8320,0	300 kcmil
37058	4 G 185	64,0 - 80,0	7104,0	9800,0	350 kcmil
37059	4 G 240	72,0 - 91,0	9216,0	12100,0	500 kcmil
37060	4 G 300	80,0 - 101,0	11520,0	15200,0	600 kcmil
37061	5 G 1,5	11,2 - 14,4	72,0	240,0	16
37062	5 G 2,5	13,3 - 17,0	120,0	345,0	14
37063	5 G 4	15,6 - 19,9	192,0	485,0	12
37064	5 G 6	17,5 - 22,2	288,0	650,0	10
37065	5 G 10	22,9 - 29,1	480,0	1200,0	8
37066	5 G 16	26,4 - 33,3	768,0	1550,0	6
37067	5 G 25	32,0 - 40,4	1200,0	2250,0	4
37068	5 G 35	35,7 - 45,1	1680,0	2750,0	2
37091	5 G 50	41,8 - 53,0	2400,0	3950,0	1
37154	5 G 70	47,5 - 60,0	3360,0	4740,0	2/0
34090	5 G 95	54,0 - 67,0	4560,0	6600,0	3/0
34349	5 G 120	58,0 - 73,0	5760,0	8180,0	4/0
34127	5 G 150	64,0 - 80,0	7200,0	10600,0	300 kcmil
37092	7 G 1,5	14,7 - 18,7	101,0	375,0	16
37079	7 G 2,5	17,1 - 21,8	168,0	520,0	14
37093	12 G 1,5	17,6 - 22,4	175,0	460,0	16
37096	12 G 2,5	20,6 - 26,2	288,0	760,0	14
37097	18 G 2,5	24,4 - 30,9	432,0	850,0	14
37094	19 G 1,5	20,7 - 26,3	274,0	810,0	16
37098	19 G 2,5	25,5 - 31,0	456,0	1075,0	14
37095	24 G 1,5	24,3 - 30,7	346,0	1015,0	16
37099	24 G 2,5	28,8 - 36,4	576,0	1390,0	14

Dimensions and specifications may be changed without prior notice. (RF01)



# MEGAFLEX® 500

halogen-free, flame retardant, oil-resistant, UV-resistant, flexible, meter marking



## Technical data

- Halogen-free flexible control cable adapted to  
DIN VDE 0285-525-3-11/  
DIN EN 50525-3-11,  
to UL-Style 20939, UL-Std.758
- **Temperature range**  
flexing -30°C to +80°C  
fixed installation -40°C to +80°C
- **Nominal voltage**  
U<sub>0</sub>/U 300/500 V  
UL/CSA 600 V
- **Test voltage** 3000 V
- **Minimum bending radius**  
flexing 10x cable Ø  
fixed installation 4x cable Ø
- **Flexibility**  
Alternate bending test acc. to  
DIN VDE 0473-396 / DIN EN 50396

## Cable structure

- Bare copper-conductor, to  
DIN VDE 0295 cl.5, fine-wire,  
BS 6360 cl.5, IEC 60228 cl.5
- Core insulation of halogen-free  
special polymer
- Core identification to DIN VDE 0293  
black cores with continuous white  
numbering
- GN-YE conductor, 3 cores and above  
in the outer layer
- Cores stranded in layers with  
optimal lay-length
- Outer sheath of halogen-free  
special polymer
- Sheath colour grey (RAL 7001)
- with meter marking
- **LSOH**= Low Smoke Zero Halogen

## Note

- G = with green-yellow conductor  
x = without green-yellow conductor (OZ)
- Also available as a 0,6/1 kV cable  
MEGAFLEX® 600
- AWG sizes are approximate equivalent  
values. The actual cross-section is in mm<sup>2</sup>.
- screened analogue type:  
**MEGAFLEX® 500-C**

## Properties

- Highly flame-retardant
- Resistant to oils and greases
- Resistant to UV and weathering
- Hydrolysis resistant
- Flexible, abrasion- and wear-resistant
- Ozone-resistant, recyclable
- The materials used in manufacture are  
cadmium-free and contain no silicone  
and free from substances harmful to  
the wetting properties of lacquers

## Tests

- Flame test acc. to DIN VDE 0482-332-3-24,  
BS 4066 part 3, DIN EN 60332-3-24,  
IEC 60332-3-24 (previously DIN VDE 0472  
part 804 test method C)
- Self-extinguishing and flame retardant  
acc. to DIN VDE 0482-332-1-2,  
DIN EN 60332-1-2 / IEC 60332-1 (previously  
DIN VDE 0472 part 804 test method B),  
CSA FT1
- Corrosiveness of combustion gases  
acc. to NF X 10-702
- Halogen-free acc. to DIN VDE 0482  
part 267 / DIN EN 50267-2-1 / IEC 60754-1  
(equivalent DIN VDE 0472 part 815)
- Smoke density acc. to DIN VDE 0482  
part 1034-1+2, DIN EN 61034-1+2,  
IEC 61034-1+2, BS 7622 part 1+2  
(previously DIN VDE 0472 part 816)
- Oil-resistant to DIN VDE 0473-811-404/  
DIN EN 60811-404
- Hydrolysis-resistant to DIN EN 61234-1
- Ozone-resistant to  
DIN VDE 0473-811-403/DIN EN 60811-403

## Application

For fixed installation or flexible application, with free movements without forcing which do not constantly recur and without tensile stress, for high mechanical strain. As a measuring and control cable primarily in machinery and plant construction, in air-conditioning systems, at the warehouse and conveyor systems, in ship-building and in the renewable energies such as in the construction of wind power stations.

CE= The product is conformed with the EC Low-Voltage Directive 2006/95/EC.

Part no.	No. cores x cross-sec. mm <sup>2</sup>	Outer Ø app. mm	Cop. weight kg / km	Weight app. kg / km	AWG-No.
13344	2 x 0,5	5,0	9,6	43,0	20
13345	3 G 0,5	5,3	14,4	50,0	20
13346	3 x 0,5	5,3	14,4	50,0	20
13347	4 G 0,5	5,7	19,0	60,0	20
13348	4 x 0,5	5,7	19,0	60,0	20
13349	5 G 0,5	6,2	24,0	71,0	20
13350	5 x 0,5	6,2	24,0	71,0	20
13351	7 G 0,5	7,4	33,6	84,0	20
13352	8 G 0,5	8,0	38,0	101,0	20
13353	10 G 0,5	8,8	48,0	121,0	20
13354	12 G 0,5	9,1	58,0	142,0	20
13355	16 G 0,5	10,0	76,0	183,0	20

Part no.	No. cores x cross-sec. mm <sup>2</sup>	Outer Ø app. mm	Cop. weight kg / km	Weight app. kg / km	AWG-No.
13356	18 G 0,5	10,7	86,0	204,0	20
13357	20 G 0,5	11,2	96,0	227,0	20
13359	25 G 0,5	12,7	120,0	283,0	20
13360	30 G 0,5	13,5	144,0	324,0	20
13361	34 G 0,5	14,5	163,0	367,0	20
13362	37 G 0,5	14,5	178,0	381,0	20
13363	41 G 0,5	15,8	197,0	417,0	20
13364	42 G 0,5	15,8	202,0	454,0	20
13365	50 G 0,5	17,3	240,0	519,0	20
13366	61 G 0,5	18,5	293,0	635,0	20
13367	65 G 0,5	19,4	312,0	694,0	20

Continuation ▶

# MEGAFLEX® 500

halogen-free, flame retardant, oil-resistant, UV-resistant, flexible, meter marking



Part no.	No.cores x cross-sec. mm²	Outer Ø app. mm	Cop. weight kg / km	Weight app. kg / km	AWG-No.
13368	2 x 0,75	5,4	14,4	47,0	19
13369	3 G 0,75	5,7	21,6	56,0	19
13370	3 x 0,75	5,7	21,6	56,0	19
13371	4 G 0,75	6,2	29,0	69,0	19
13372	4 x 0,75	6,2	29,0	69,0	19
13373	5 G 0,75	6,8	36,0	83,0	19
13374	5 x 0,75	6,8	36,0	83,0	19
13375	7 G 0,75	8,1	50,0	114,0	19
13376	7 x 0,75	8,1	50,0	114,0	19
13377	8 G 0,75	8,9	58,0	136,0	19
13378	10 G 0,75	9,6	72,0	172,0	19
13379	12 G 0,75	9,9	86,0	183,0	19
13380	16 G 0,75	11,2	115,0	241,0	19
13381	18 G 0,75	11,9	130,0	266,0	19
13382	20 G 0,75	12,6	144,0	291,0	19
13383	25 G 0,75	14,1	180,0	374,0	19
13384	30 G 0,75	15,4	216,0	450,0	19
13385	34 G 0,75	16,4	245,0	517,0	19
13386	37 G 0,75	16,4	260,0	541,0	19
13387	41 G 0,75	17,6	296,0	611,0	19
13388	42 G 0,75	17,6	302,0	621,0	19
13389	50 G 0,75	19,8	360,0	742,0	19
13390	61 G 0,75	20,9	439,0	853,0	19
13392	65 G 0,75	21,8	468,0	909,0	19
13393	2 x 1	5,7	19,2	63,0	18
13394	3 G 1	6,0	29,0	74,0	18
13395	3 x 1	6,0	29,0	74,0	18
13396	4 G 1	6,6	38,4	90,0	18
13397	4 x 1	6,6	38,4	90,0	18
13398	5 G 1	7,2	48,0	109,0	18
13399	7 G 1	8,6	67,0	151,0	18
13400	8 G 1	9,4	77,0	184,0	18
13401	10 G 1	10,4	96,0	224,0	18
13402	12 G 1	10,7	115,0	243,0	18
13403	16 G 1	12,0	154,0	314,0	18
13404	18 G 1	12,7	173,0	361,0	18
13405	20 G 1	13,5	192,0	387,0	18
13406	25 G 1	15,2	240,0	496,0	18
13407	34 G 1	17,4	326,0	670,0	18
13408	37 G 1	17,4	355,0	713,0	18
13409	41 G 1	18,9	394,0	784,0	18
13410	42 G 1	18,9	403,0	824,0	18
13411	50 G 1	21,0	480,0	952,0	18
13412	61 G 1	22,2	586,0	1140,0	18
13413	65 G 1	23,2	628,0	1201,0	18
13414	2 x 1,5	6,3	29,0	70,0	16
13415	3 G 1,5	6,6	43,0	94,0	16
13416	3 x 1,5	6,6	43,0	94,0	16
13417	4 G 1,5	7,2	58,0	112,0	16
13418	5 G 1,5	7,9	72,0	141,0	16
13419	7 G 1,5	9,5	101,0	191,0	16
13420	8 G 1,5	10,4	115,0	224,0	16
13421	10 G 1,5	11,3	144,0	282,0	16
13422	12 G 1,5	11,7	173,0	311,0	16
13423	16 G 1,5	13,3	230,0	392,0	16
13425	18 G 1,5	14,0	259,0	450,0	16
13426	20 G 1,5	14,9	288,0	497,0	16
13427	25 G 1,5	16,8	360,0	630,0	16
13428	34 G 1,5	19,4	490,0	842,0	16
13429	37 G 1,5	19,4	533,0	897,0	16
13430	50 G 1,5	23,4	720,0	1277,0	16
13431	61 G 1,5	24,8	878,0	1460,0	16
13432	65 G 1,5	25,8	936,0	1612,0	16

Part no.	No.cores x cross-sec. mm²	Outer Ø app. mm	Cop. weight kg / km	Weight app. kg / km	AWG-No.
13433	2 x 2,5	7,6	48,0	118,0	14
13434	3 G 2,5	8,3	72,0	151,0	14
13435	4 G 2,5	9,1	96,0	181,0	14
13436	5 G 2,5	10,2	120,0	224,0	14
13437	7 G 2,5	12,1	168,0	316,0	14
13438	8 G 2,5	13,2	192,0	370,0	14
13439	10 G 2,5	14,6	240,0	451,0	14
13440	12 G 2,5	15,2	288,0	499,0	14
13441	16 G 2,5	16,8	384,0	720,0	14
13442	18 G 2,5	18,1	432,0	769,0	14
13443	20 G 2,5	19,0	480,0	911,0	14
13444	25 G 2,5	22,2	600,0	1047,0	14
13445	30 G 2,5	22,9	720,0	1280,0	14
13446	2 x 4	9,2	77,0	199,0	12
13447	3 G 4	9,9	115,0	247,0	12
13448	4 G 4	11,0	154,0	299,0	12
13449	5 G 4	12,1	192,0	369,0	12
13450	7 G 4	13,3	269,0	463,0	12
13451	8 G 4	15,9	307,0	601,0	12
13452	10 G 4	17,3	384,0	698,0	12
13453	12 G 4	18,3	461,0	790,0	12
13454	16 G 4	20,2	614,0	1130,0	12
13455	18 G 4	21,8	691,0	1280,0	12
13456	2 x 6	10,8	115,0	266,0	10
13457	3 G 6	11,7	173,0	360,0	10
13458	4 G 6	13,0	230,0	429,0	10
13459	5 G 6	14,5	288,0	529,0	10
13460	7 G 6	16,0	403,0	631,0	10
13461	2 x 10	14,0	192,0	440,0	8
13462	3 G 10	15,0	288,0	550,0	8
13463	4 G 10	16,8	384,0	708,0	8
13464	5 G 10	18,7	480,0	862,0	8
13465	7 G 10	20,6	672,0	1124,0	8
13466	2 x 16	16,5	307,0	642,0	6
13467	3 G 16	17,6	461,0	830,0	6
13468	4 G 16	19,7	641,0	1060,0	6
13469	5 G 16	21,9	768,0	1270,0	6
13470	7 G 16	24,4	1075,0	1794,0	6
13471	3 G 25	22,5	720,0	1190,0	4
13472	4 G 25	25,2	960,0	1594,0	4
13473	5 G 25	27,9	1200,0	2014,0	4
13474	3 G 35	26,3	1008,0	1590,0	2
13475	4 G 35	28,5	1344,0	2200,0	2
13476	5 G 35	31,2	1680,0	2693,0	2
13477	3 G 50	30,2	1440,0	2571,0	1
13478	4 G 50	34,0	1920,0	3087,0	1
13479	5 G 50	37,8	2400,0	3980,0	1
13480	3 G 70	37,0	2016,0	3207,0	2/0
13481	4 G 70	41,5	2688,0	4077,0	2/0
13482	5 G 70	46,2	3360,0	5501,0	2/0
13483	3 G 95	41,4	2736,0	4708,0	3/0
13484	4 G 95	46,2	3648,0	5590,0	3/0
13485	5 G 95	51,5	4560,0	6972,0	3/0
13486	3 G 120	45,7	3456,0	5515,0	4/0
13487	4 G 120	51,2	4608,0	7100,0	4/0
13488	3 G 150	52,8	4320,0	6279,0	300 kcmil
13489	4 G 150	58,3	5760,0	7781,0	300 kcmil

Dimensions and specifications may be changed without prior notice. (RA03)

# MEGAFLEX® 500-C

halogen-free, flame retardant, oil-resistant, UV-resistant, flexible, screened, EMC-preferred types, meter marking



## Technical data

- Halogen-free flexible control cable adapted to DIN VDE 0285-525-3-11 / DIN EN 50525-3-11, to UL-Style 20939, UL-Std.758
- **Temperature range**  
flexing -30°C to +80°C  
fixed installation -40°C to +80°C
- **Nominal voltage**  
U<sub>0</sub>/U 300/500 V  
UL/CSA 600 V
- **Test voltage** 3000 V
- **Coupling resistance**  
max. 250 Ohm/km
- **Minimum bending radius**  
flexing 10x cable Ø  
fixed installation 4x cable Ø
- **Flexibility**  
Alternate bending test acc. to DIN VDE 0473-396 / DIN EN 50396

## Cable structure

- Bare copper, fine wire conductors, to DIN VDE 0295 cl.5, BS 6360 cl.5 and IEC 60228 cl.5
- Core insulation of halogen-free special polymer
- Core identification to DIN VDE 0293 black cores with continuous white numbering
- GN-YE conductor, 3 cores and above in the outer layer
- Cores stranded in layers with optimal lay-length
- Separating foil
- Tinned copper braided screen, approx. 85% coverage
- Outer sheath of halogen-free special polymer
- Sheath colour grey (RAL 7001)
- with meter marking
- **LS0H**= Low Smoke Zero Halogen

## Note

- G = with green-yellow conductor  
x = without green-yellow conductor (OZ)
- AWG sizes are approximate equivalent values. The actual cross-section is in mm<sup>2</sup>.
- unscreened analogue type:  
**MEGAFLEX® 500**

## Properties

- Halogen-free
- Highly flame-retardant
- Resistant to oils and greases
- Resistant to UV and weathering
- Flexible, abrasion- and wear-resistant
- Ozone-resistant
- Recyclable
- The materials used in manufacture are cadmium-free and contain no silicone and free from substances harmful to the wetting properties of lacquers

## Tests

- Flame test acc. to DIN VDE 0482-332-3-24, BS 4066 part 3, DIN EN 60332-3-24, IEC 60332-3-24 (previously DIN VDE 0472 part 804 test method C)
- Self-extinguishing and flame retardant acc. to DIN VDE 0482-332-1-2, DIN EN 60332-1-2, IEC 60332-1 (previously DIN VDE 0472 part 804 test method B) CSA FT1
- Corrosiveness of combustion gases acc. to NF X 10-702
- Halogen-free acc. to DIN VDE 0482 part 267, DIN EN 50267-2-1, IEC 60754-1 (equivalent DIN VDE 0472 part 815)
- Smoke density acc. to DIN VDE 0482 part 1034-1+2, DIN EN 61034-1+2, IEC 61034-1+2, BS 7622 part 1+2 (previously DIN VDE 0472 part 816)
- Oil-resistant to DIN VDE 0473-811-404 / DIN EN 60811-404
- Hydrolysis resistant to DIN EN 61234-1
- Ozone-resistant to DIN VDE 0473-811-403 / DIN EN 60811-403

## Application

For fixed installation or flexible application that does not permanently recurring free movement without forced motion and without tensile stress, for high mechanical strain. As a measuring and control cable e. g. in machine and plant engineering, air conditioning in the warehouse and materials handling, shipbuilding and in the newable energies such as wind power stations.

**EMC** = Electromagnetic compatibility

To optimize the EMC features we recommend a large round contact of the copper braiding on both ends.

**CE** = The product is conformed with the EC Low-Voltage Directive 2006/95/EC.

Part no.	No. cores x cross-sec. mm <sup>2</sup>	Outer Ø app. mm	Cop. weight kg / km	Weight app. kg / km	AWG-No.
13500	2 x 0,5	5,7	35,0	46,0	20
13501	3 G 0,5	6,0	42,0	56,0	20
13502	3 x 0,5	6,0	42,0	56,0	20
13503	4 G 0,5	6,5	47,0	62,0	20
13504	4 x 0,5	6,5	47,0	62,0	20
13505	5 G 0,5	7,0	56,0	75,0	20
13506	5 x 0,5	7,0	56,0	75,0	20
13507	7 G 0,5	7,9	69,0	98,0	20
13508	8 G 0,5	8,5	80,0	116,0	20
13509	10 G 0,5	9,3	94,0	135,0	20
13510	12 G 0,5	9,6	108,0	158,0	20
13511	16 G 0,5	10,7	129,0	210,0	20
13512	18 G 0,5	11,2	145,0	216,0	20
13514	20 G 0,5	11,9	172,0	240,0	20
13515	25 G 0,5	13,4	240,0	315,0	20

Part no.	No. cores x cross-sec. mm <sup>2</sup>	Outer Ø app. mm	Cop. weight kg / km	Weight app. kg / km	AWG-No.
13516	2 x 0,75	6,1	40,0	60,0	19
13517	3 G 0,75	6,4	52,0	68,0	19
13518	3 x 0,75	6,4	52,0	68,0	19
13519	4 G 0,75	6,9	60,0	78,0	19
13520	4 x 0,75	6,9	60,0	78,0	19
13521	5 G 0,75	7,4	71,0	95,0	19
13522	5 x 0,75	7,4	71,0	95,0	19
13523	7 G 0,75	8,6	91,0	130,0	19
13524	7 x 0,75	8,6	91,0	130,0	19
13525	8 G 0,75	9,4	110,0	145,0	19
13526	10 G 0,75	10,2	137,0	180,0	19
13527	12 G 0,75	10,4	142,0	203,0	19
13528	16 G 0,75	11,6	200,0	275,0	19
13529	18 G 0,75	12,4	212,0	290,0	19
13530	20 G 0,75	12,9	238,0	320,0	19

Continuation ▶

# MEGAFLEX® 500-C

halogen-free, flame retardant, oil-resistant, UV-resistant, flexible, screened,  
EMC-preferred types, meter marking



Part no.	No.cores x cross-sec. mm <sup>2</sup>	Outer Ø app. mm	Cop. weight kg / km	Weight app. kg / km	AWG-No.
13531	25 G 0,75	14,8	281,0	413,0	19
13532	2 x 1	6,4	50,0	66,0	18
13533	3 G 1	6,7	60,0	80,0	18
13534	3 x 1	6,7	60,0	80,0	18
13535	4 G 1	7,3	71,0	100,0	18
13536	4 x 1	7,3	71,0	100,0	18
13537	5 G 1	7,8	88,0	130,0	18
13538	7 G 1	9,1	111,0	160,0	18
13539	8 G 1	9,9	127,0	197,0	18
13540	10 G 1	10,8	150,0	232,0	18
13541	12 G 1	11,2	184,0	260,0	18
13542	16 G 1	12,3	209,0	346,0	18
13543	18 G 1	13,2	260,0	382,0	18
13544	20 G 1	13,8	317,0	440,0	18
13545	25 G 1	15,8	349,0	540,0	18
13546	2 x 1,5	7,0	63,0	88,0	16
13547	3 G 1,5	7,3	80,0	100,0	16
13548	3 x 1,5	7,3	80,0	100,0	16
13549	4 G 1,5	7,9	97,0	125,0	16
13550	5 G 1,5	8,6	119,0	158,0	16
13552	7 G 1,5	10,2	147,0	210,0	16
13554	8 G 1,5	11,1	170,0	244,0	16
13556	10 G 1,5	12,0	193,0	315,0	16
13557	12 G 1,5	12,5	267,0	340,0	16
13558	16 G 1,5	13,8	315,0	424,0	16
13559	18 G 1,5	15,0	374,0	480,0	16
13560	20 G 1,5	15,7	396,0	545,0	16
13561	25 G 1,5	18,0	526,0	702,0	16
13562	2 x 2,5	8,3	96,0	132,0	14
13563	3 G 2,5	9,0	144,0	168,0	14
13565	4 G 2,5	9,8	148,0	195,0	14
13566	5 G 2,5	10,9	181,0	256,0	14
13567	7 G 2,5	12,9	255,0	345,0	14
13568	8 G 2,5	13,8	285,0	390,0	17
13569	10 G 2,5	15,8	340,0	482,0	14
13570	12 G 2,5	15,9	441,0	572,0	14
13571	2 x 4	9,8	120,0	220,0	12
13572	3 G 4	10,6	174,0	251,0	12
13573	4 G 4	11,5	230,0	305,0	12
13574	5 G 4	12,7	273,0	388,0	12
13575	7 G 4	13,9	316,0	504,0	12
13576	2 x 6	11,5	173,0	270,0	10
13577	3 G 6	12,4	240,0	351,0	10

Part no.	No.cores x cross-sec. mm <sup>2</sup>	Outer Ø app. mm	Cop. weight kg / km	Weight app. kg / km	AWG-No.
13578	4 G 6	13,8	305,0	464,0	10
13579	5 G 6	15,7	439,0	546,0	10
13580	7 G 6	16,6	505,0	670,0	10
13581	2 x 10	14,9	255,0	461,0	8
13582	3 G 10	15,9	350,0	574,0	8
13583	4 G 10	17,8	535,0	785,0	8
13584	5 G 10	19,6	592,0	914,0	8
13585	7 G 10	21,6	810,0	1308,0	8
13586	2 x 16	17,3	422,0	670,0	6
13587	3 G 16	18,5	585,0	911,0	6
13588	4 G 16	20,8	740,0	1105,0	6
13589	5 G 16	22,9	895,0	1293,0	6
13590	7 G 16	25,0	1282,0	2149,0	6
13591	4 G 25	26,2	1140,0	1911,0	4
13592	4 x 35	30,4	1576,0	2542,0	2
13593	4 G 50	34,6	2155,0	3550,0	1
13594	4 G 70	41,3	3120,0	4939,0	2/0
13595	4 G 95	46,2	4043,0	6690,0	3/0
13596	4 G 120	51,0	5069,0	8453,0	4/0
13597	4 G 150	59,0	5792,0	9104,0	300 kcmil

Dimensions and specifications may be changed without prior notice. (RA03)



## Technical data

- Special silicone multicores cable with higher heat-resistance range adapted to DIN VDE 0250 part 1 and DIN VDE 0285-525-2-83/ DIN EN 50525-2-83
- **Temperature range**  
-60°C to +180°C  
(for short time +220°C)
- **Temperature limit** at the conductor in operation +180°C
- **Nominal voltage**  $U_0/U$  300/500 V
- **Test voltage** 2000 V
- **Breakdown voltage** min. 5000 V
- **Insulation resistance**  
min. 200 MOhm x km
- **Power rating**  
ambient temperature up to +145°C to DIN VDE 0100  
for higher temperatures valid:  
150°C - load value 100%  
155°C - load value 91%  
160°C - load value 82%  
165°C - load value 71%  
170°C - load value 58%  
175°C - load value 41%
- **Minimum bending radius**  
flexing 7,5x cable Ø  
fixed installation 4x cable Ø
- **Radiation resistance**  
up to 20x10<sup>6</sup> cJ/kg (up to 20 Mrad)

## Cable structure

- Tinned copper-conductor, to DIN VDE 0295 cl.5, fine-wire, BS 6360 cl.5, IEC 60228 cl.5
- Core insulation of silicone
- Core identification to DIN VDE 0293-308  
- up to 5 cores coloured  
- from 6 cores, black with continuous white numbering
- GN-YE conductor, 3 cores and above
- Cores stranded in layers with optimal lay-length
- Outer sheath of silicone
- Sheath colour preferably redbrown
- with meter marking

## Properties

- **Advantages**  
Hardly changes of dielectric strength and the insulation resistance also at high temperatures, high ignition or flash point, in case of fire, forms an insulating layer of SiO<sub>2</sub>
- **Resistant to**  
High molecular oils, fats from vegetables and animals, alcohols, plasticizers and clophenes, diluted acids, lyes and salt dissolution, oxidation substances, tropical influences and weather, lake water, oxygen, ozone
- For laying as a fixed installation only in open or ventilated pipe systems as well as in ducts. Otherwise the mechanical properties of the silicon are reduced by the enclosed air at temperatures exceeding 90°C.

## Tests

- Halogen-free  
acc. to DIN VDE 0482 part 267, DIN EN 50267-2-2/ IEC 60754-2 (equivalent DIN VDE 0472 part 813)
- **Behaviour in fire**  
no flame propagation acc. to DIN VDE 0482-332-1-2, DIN EN 60332-1-2, IEC 60332-1 (equivalent DIN VDE 0472 part 804 test method B)

## Note

- G = with green-yellow conductor  
x = without green-yellow conductor (OB)
- AWG sizes are approximate equivalent values. The actual cross-section is in mm<sup>2</sup>.
- screened analogue type:  
**SIHF-C-SI**

## Application

Silicone cables were evolved for use wherever insulation is subjected to extreme temperature changes. They are heat-resistant for permanent temperature up to +180°C, for short time operation up to +220°C. The good performance of the environmental resistant properties means that silicone cables can be used at temperatures down to -60°C. Silicone cables are halogen-free cables and are especially suited for installation in power stations. They have also found their uses in the steel producing industries, aviation industry, ship building as well as in ceramic, glass and cement factories. Due to elastical characteristic of core insulations, these are used as flexible connection cable.

CE= The product is conformed with the EC Low-Voltage Directive 2006/95/EC.

Part no.	No. cores x cross-sec. mm <sup>2</sup>	Outer Ø app. mm	Cop. weight kg / km	Weight app. kg / km	AWG-No.
22989	2 x 0,5	5,6	9,6	42,0	20
22990	3 G 0,5	5,9	14,5	44,0	20
22940	3 x 0,5	5,9	14,5	44,0	20
22991	4 G 0,5	6,4	19,3	58,0	20
22941	4 x 0,5	6,4	19,3	58,0	20
22992	5 G 0,5	7,3	24,0	62,0	20
22942	5 x 0,5	7,3	24,0	62,0	20
22993	6 G 0,5	8,3	28,9	79,0	20
22994	7 G 0,5	8,1	33,7	85,0	20
22995	8 G 0,5	8,9	38,4	99,0	20
22996	10 G 0,5	10,0	48,1	124,0	20
22997	12 G 0,5	10,6	57,6	141,0	20
22998	16 G 0,5	12,1	76,7	186,0	20
22999	18 G 0,5	12,7	86,5	211,0	20
23000	25 G 0,5	15,2	120,0	271,0	20

Part no.	No. cores x cross-sec. mm <sup>2</sup>	Outer Ø app. mm	Cop. weight kg / km	Weight app. kg / km	AWG-No.
23001	2 x 0,75	6,4	14,4	53,0	19
23002	3 G 0,75	6,8	21,6	63,0	19
23104	3 x 0,75	6,8	21,6	63,0	19
23003	4 G 0,75	7,6	29,0	83,0	19
23105	4 x 0,75	7,6	29,0	83,0	19
23004	5 G 0,75	8,5	36,0	101,0	19
22943	5 x 0,75	8,5	36,0	101,0	19
23005	6 G 0,75	9,2	43,0	115,0	19
23006	7 G 0,75	9,2	50,0	124,0	19
23127	8 G 0,75	9,9	57,7	138,0	19
23128	10 G 0,75	11,1	72,1	156,0	19
23129	12 G 0,75	12,2	86,5	185,0	19
23130	16 G 0,75	13,7	115,2	218,0	19
23131	18 G 0,75	14,6	129,7	260,0	19
23132	25 G 0,75	17,2	180,0	370,0	19

Continuation ▶

Part no.	No.cores x cross-sec. mm <sup>2</sup>	Outer Ø app. mm	Cop. weight kg / km	Weight app. kg / km	AWG-No.
23007	2 x 1	6,6	19,0	59,0	18
23008	3 G 1	7,0	29,0	77,0	18
22944	3 x 1	7,0	29,0	77,0	18
23009	4 G 1	7,8	38,0	94,0	18
22945	4 x 1	7,8	38,0	94,0	18
23010	5 G 1	8,8	48,0	115,0	18
22946	5 x 1	8,8	48,0	115,0	18
23011	6 G 1	9,5	58,0	134,0	18
23012	7 G 1	9,5	67,0	144,0	18
23133	8 G 1	10,3	76,7	175,0	18
24000	9 G 1	11,5	86,0	196,0	18
23134	10 G 1	11,5	96,1	216,0	18
23135	12 G 1	12,5	115,2	231,0	18
23136	16 G 1	14,2	153,5	302,0	18
23137	18 G 1	15,1	172,9	340,0	18
23138	25 G 1	18,0	240,0	431,0	18
23013	2 x 1,5	7,6	29,0	81,0	16
23014	3 G 1,5	8,0	43,0	98,0	16
22947	3 x 1,5	8,0	43,0	98,0	16
23015	4 G 1,5	8,7	58,0	122,0	16
22948	4 x 1,5	8,7	58,0	122,0	16
23016	5 G 1,5	9,6	72,0	147,0	16
22949	5 x 1,5	9,6	72,0	147,0	16
23017	6 G 1,5	10,4	86,0	173,0	16
23018	7 G 1,5	10,4	101,0	187,0	16
23019	8 G 1,5	11,2	114,0	213,0	16
23020	10 G 1,5	13,0	116,0	263,0	16
23021	12 G 1,5	13,9	173,0	314,0	16
23022	14 G 1,5	14,7	202,0	379,0	16
23023	16 G 1,5	16,2	231,0	445,0	16
23024	18 G 1,5	17,0	260,0	506,0	16
23025	20 G 1,5	17,5	288,0	566,0	16
23026	24 G 1,5	20,4	346,0	722,0	16

Part no.	No.cores x cross-sec. mm <sup>2</sup>	Outer Ø app. mm	Cop. weight kg / km	Weight app. kg / km	AWG-No.
23027	2 x 2,5	8,8	48,0	134,0	14
23028	3 G 2,5	9,7	72,0	152,0	14
23029	4 G 2,5	10,6	96,0	188,0	14
23030	5 G 2,5	11,6	120,0	228,0	14
23139	6 G 2,5	12,6	144,0	304,0	14
23032	7 G 2,5	12,6	168,0	320,0	14
23140	8 G 2,5	13,6	192,2	373,0	14
23141	10 G 2,5	15,5	240,1	450,0	14
23033	12 G 2,5	17,1	288,0	502,0	14
23142	16 G 2,5	19,6	384,0	659,0	14
23143	18 G 2,5	20,6	432,2	761,0	14
23144	25 G 2,5	24,4	600,0	1007,0	14
23034	2 x 4	10,8	77,0	180,0	12
23035	3 G 4	11,4	115,0	224,0	12
23036	4 G 4	12,5	154,0	295,0	12
23037	5 G 4	13,9	192,0	359,0	12
23039	7 G 4	15,6	269,0	479,0	12
23040	2 x 6	12,4	115,0	210,0	10
23041	3 G 6	13,2	173,0	270,0	10
23042	4 G 6	14,8	230,0	341,0	10
23043	5 G 6	16,5	288,0	432,0	10
23045	7 G 6	18,0	403,0	552,0	10
23046	2 x 10	16,2	192,0	400,0	8
23047	3 G 10	17,2	288,0	507,0	8
23048	4 G 10	19,4	384,0	644,0	8
23049	5 G 10	21,4	480,0	788,0	8
23145	7 G 10	23,4	672,2	1151,0	8
23050	2 x 16	18,0	308,0	591,0	6
23051	3 G 16	19,3	462,0	749,0	6
23052	4 G 16	21,4	616,0	950,0	6
23053	5 G 16	24,0	770,0	1204,0	6
23146	7 G 16	26,4	1075,3	1682,0	6
23054	2 x 25	22,0	480,0	700,0	4
23055	3 G 25	23,4	720,0	1100,0	4
23056	4 G 25	26,3	960,0	1500,0	4
23057	2 x 35	24,6	672,0	1100,0	2
23058	3 G 35	26,3	1008,0	1500,0	2
23059	4 G 35	29,1	1344,0	2100,0	2

Dimensions and specifications may be changed without prior notice. (RE01)



# H07V-K / (H)07V-K

PVC-Single Cores, fine wire stranded

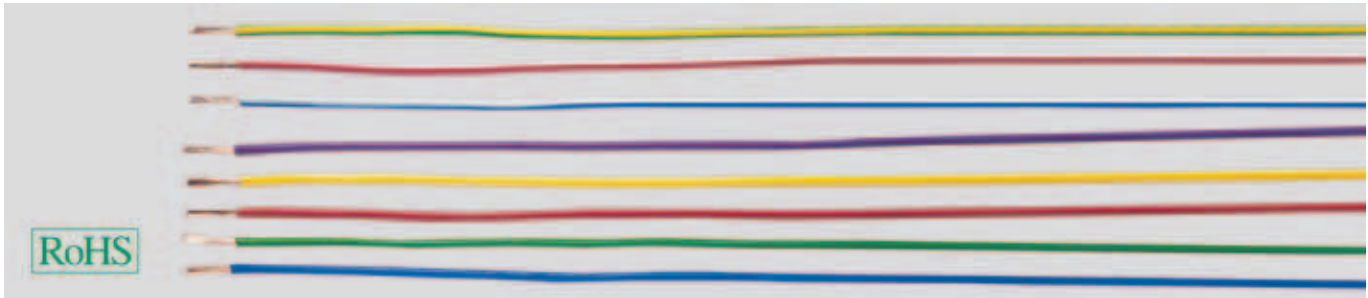

## Technical data

- PVC single cores to  
DIN VDE 0285-525-2-31/  
DIN EN 50525-2-31 and IEC 60227-3
- **Temperature range**  
flexing -5°C to +70°C  
fixed installation -30°C to +80°C
- **Nominal voltage**  $U_0/U$  450/750 V
- **Test voltage** 2500 V
- **Insulation resistance**  
min. 10 MΩ x km
- **Minimum bending radius**  
fixed installation  
core  $\varnothing \leq 8$  mm: 4x core  $\varnothing$   
core  $\varnothing > 8-12$  mm: 5x core  $\varnothing$   
core  $\varnothing > 12$  mm: 6x core  $\varnothing$
- **Radiation resistance**  
up to  $80 \times 10^6$  cJ/kg (up to 80 Mrad)

## Cable structure

- Bare Cu-conductor, to  
DIN VDE 0295 cl.5, fine-wire,  
BS 6360 cl.5, IEC 60228 cl.5
- Core insulation of PVC  
compound type T11 to  
DIN VDE 0207-363-3 / DIN EN 50363-3  
and IEC 60227-3
- Core identification see table below

## Properties

- The materials used in manufacture are cadmium-free and contain no silicone and free from substances harmful to the wetting properties of lacquers
- ### Tests
- PVC self-extinguishing and flame retardant acc. to DIN VDE 0482-332-1-2, DIN EN 60332-1-2, IEC 60332-1 (equivalent DIN VDE 0472 part 804 test method B)

## Note

- The following colours are recommended (only single colour): black, white, blue, grey, brown, red, orange, turquoise, violet and pink. Two-coloured combinations are not allowed, with exceptions of green-yellow.
- Colours yellow, green, transparent only in (H)07V-K available.
- Two-coloured combination is only permitted for (H)07V-K.

## Application

These single cores are suitable for laying in tubes, under and surface mounting of plasters and also in closed installation conduits. These are not allowed to install for direct laying on cable trays, channels or tanks. These types are permitted for the inner wiring of equipment, distributor and switchboards and also for protective laying to the lightings with a nominal voltage up to 1000 V alternating current or up to 750 V direct current against earth.

CE= The product is conformed with the EC Low-Voltage Directive 2006/95/EC.

## H07V-K, (H)07V-K

Cross-sec. mm <sup>2</sup> app. RAL	Outer Ø min. mm	max. mm	Cop. weight kg / km	BK	GN-YE	BU	BN	RD	WH	GY	VT	YE	PK	GN	TRANS	D-BU	OG	2-col.	U-BU
				9005	-	5015	8003	3000	9003	7001	4005	1021	3015	6018	-	5010	2003	-	5002



### Coil in cardboard (100m)

Packing			H07V-K coil																
Part no.	Outer Ø min. mm	max. mm	29129	29130	29131	29132	29133	29134	29135	29136	29137	29138	29139	29140	29141	29142	29144	26395	
1,5	2,8 - 3,4	14,4	29145	29146	29147	29148	29149	29150	29151	29152	29153	29154	29155	29156	29157	29158	29160	26396	
2,5	3,4 - 4,1	24,0	29161	29162	29163	29164	29165	29166	29167	29168	29169	29170	29171	29172	29173	29174	29176	26397	
4	3,9 - 4,8	38,0	29177	29178	29179	29180	29181	29182	29183	29184	29185	29186	29187	29188	29189	29190	29192	26398	
6	4,4 - 5,3	58,0																	



### Spool (with various capacity)

Packing			H07V-K spool																
Part no.	Outer Ø min. mm	max. mm	26690	26691	26692	26693	26694	26695	26696	26697	26698	26699	26700	26701	26702	26703	26705	26399	
1,5	2,8 - 3,4	14,4	26706	26707	26708	26709	26710	26711	26712	26713	26714	26715	26716	26717	26718	26719	26721	26400	
2,5	3,4 - 4,1	24,0	26722	26723	26724	26725	26726	26727	26728	26729	26730	26731	26732	26733	26734	26735	26737	26401	
4	3,9 - 4,8	38,0	26738	26739	26740	26741	26742	26743	26744	26745	26746	26747	26748	26749	26750	26751	26753	26402	
6	4,4 - 5,3	58,0																	

Continuation ▶

# H07V-K / (H)07V-K

PVC-Single Cores, fine wire stranded

H07V-K, (H)07V-K



Cross-sec. mm²	Outer Ø min. - max. mm	Cop. weight kg / km	BK	GN-YE	BU	BN	RD	WH	GY	VT	YE	PK	GN	TRANS	D-BU	OG	2-col.	U-BU
app. RAL			9005	-	5015	8003	3000	9003	7001	4005	1021	3015	6018	-	5010	2003	-	-



**Packing**

**Barrel (with various capacity)**

H07V-K barrel																		
Part no.			26755	26756	26757	26758	26759	26760	26761	26762	26763	26764	26765	26766	26767	26768	26770	26403
1,5	2,8 - 3,4	14,4																
Part no.			26771	26772	26773	26774	26775	26776	26777	26778	26779	26780	26781	26782	26783	26784	26786	26404
2,5	3,4 - 4,1	24,0																
Part no.			26787	26788	26789	26790	26791	26792	26793	26794	26795	26796	26797	26798	26799	26800	26802	26819
4	3,9 - 4,8	38,0																
Part no.			26803	26804	26805	26806	26807	26808	26809	26810	26811	26812	26813	26814	26815	26816	26818	26820
6	4,4 - 5,3	58,0																



**Packing**

**Coil in foil (100m)**

H07V-K coil																		
Part no.			26060	26061	26062	26063	26064	26065	26066	26067	26068	26069	26092	26099	26108	26109	26111	26821
1,5	2,8 - 3,4	14,4																
Part no.			26112	26113	26114	26115	26116	26117	26118	26119	29855	29856	29857	29858	29859	29890	29892	26822
2,5	3,4 - 4,1	24,0																
Part no.			29893	29894	29895	29896	29897	29898	29899	29905	29906	29907	29908	29909	29910	29911	29913	26823
4	3,9 - 4,8	38,0																
Part no.			29914	29915	29916	29917	29918	29919	29921	29922	29923	29924	29925	29926	29927	29928	29933	26824
6	4,4 - 5,3	58,0																
Part no.			29193	29194	29195	29196	29197	29198	29199	29200	29201	29202	29203	29204	29205	29206	29208	-
10	5,7 - 6,8	96,0																
Part no.			29209	29210	29211	29212	29213	29214	29215	29216	29217	29218	29219	29220	29221	29222	29224	-
16	6,7 - 8,1	154,0																
Part no.			29225	29226	29227	29228	29229	29230	29231	29232	29233	29234	29235	29236	29237	29238	29240	-
25	8,4 - 10,2	240,0																
Part no.			29241	29242	29243	29244	29245	29246	29247	29248	29249	29250	29251	29252	29253	29254	29256	-
35	9,7 - 11,7	336,0																
Part no.			29257	29258	29259	29260	29261	29262	29263	29264	29265	29266	29267	29268	29269	29270	29272	-
50	11,5 - 13,9	480,0																
Part no.			29273	29274	29275	29276	29277	29278	29279	29280	29281	29282	29283	29284	29285	29286	29288	-
70	13,2 - 16,0	672,0																
Part no.			29289	29290	29291	29292	29293	29294	29295	29296	29297	29298	29299	29300	29301	29302	29304	-
95	15,1 - 18,2	912,0																
Part no.			29418	29419	29420	29421	29422	29423	29424	29425	29426	29427	29428	29429	29430	29431	29433	-
120	16,7 - 20,2	1152,0																
Part no.			29434	29435	29436	29437	29438	29439	29440	29441	29442	29443	29444	29445	29446	29447	29449	-
150	18,6 - 22,5	1440,0																
Part no.			29494	29495	29496	29497	29498	29499	29590	29591	29592	29593	29594	29595	29596	29597	29599	-
185	20,6 - 24,9	1776,0																
Part no.			29813	29814	29815	29816	29817	29818	29819	29840	29841	29842	29843	29844	29845	29846	29848	-
240	23,5 - 28,4	2304,0																



**Packing**

**Drum**

H07V-K drum																		
Part no.			26825	26826	26827	26828	26829	26830	26831	26832	26833	26834	26835	26836	26837	26838	26840	-
10	5,7 - 6,8	96,0																
Part no.			26841	26842	26843	26844	26845	26846	26847	26848	26849	26850	26851	26852	26853	26854	26856	-
16	6,7 - 8,1	154,0																
Part no.			26857	26858	26859	26860	26861	26862	26863	26864	26865	26866	26867	26868	26869	26870	26872	-
25	8,4 - 10,2	240,0																
Part no.			26873	26874	26875	26876	26877	26878	26879	26880	26881	26882	26883	26884	26885	26886	26888	-
35	9,7 - 11,7	336,0																
Part no.			26889	26890	26891	26892	26893	26894	26895	26896	26897	26898	26899	26900	26901	26902	26904	-
50	11,5 - 13,9	480,0																
Part no.			26905	26906	26907	26908	26909	26910	26911	26912	26913	26914	26915	26916	26917	26918	26920	-
70	13,2 - 16,0	672,0																
Part no.			26921	26922	26923	26924	26925	26926	26927	26928	26929	26930	26931	26932	26933	26934	26936	-
95	15,1 - 18,2	912,0																
Part no.			29305	29306	29307	29308	29309	29310	29311	29312	29313	29314	29315	29316	29317	29318	29320	-
120	16,7 - 20,2	1152,0																
Part no.			29321	29322	29323	29324	29325	29326	29327	29328	29329	29330	29331	29332	29333	29334	29336	-
150	18,6 - 22,5	1440,0																
Part no.			29337	29338	29339	29340	29341	29342	29343	29344	29345	29346	29347	29348	29349	29350	29352	-
185	20,6 - 24,9	1776,0																
Part no.			29353	29354	29355	29356	29357	29358	29359	29360	29361	29362	29363	29364	29365	29366	29368	-
240	23,5 - 28,4	2304,0																

Dimensions and specifications may be changed without prior notice. (RK01)



## ■ CONNECTING CABLES

<b>Designation</b>	<b>Pages</b>
AES/EBU / DMX 512 preassembled	<b>84</b>
Speaker cable preassembled	<b>85</b>
Microphone cable preassembled	<b>86</b>
Camera cables	<b>87</b>
Rubber cable reel with HELUKAT® data cable	<b>88</b>
Rubber cable reel with HELUCOM® fibre optic cable	<b>89</b>
HELUTEK-Star, preassembled on both sides with flexible JZ-500, numbered	<b>90</b>
HELUTEK-Star, preassembled on both sides with flexible JZ-600, numbered	<b>91</b>

# DMX cable

AES/EBU & DMX 512 preassembled

HELULIGHT®



## Cable

AES/EBU & DMX cable, Part no. 400032  
AES/EBU & DMX 512, Part no. 400033

## Connector

Black HICON or Neutrik XLR plug connectors

## Application

The pre-assembled HELULIGHT® AES/EBU & DMX 512 cable is used for the transmission of digital signals in the 110 Ω AES/EBU and DMX data formats.

### AES/EBU & DMX cables

#### XLR male ⇔ XLR female 3-pin, HICON

Part no.	Length
410056	3,0 m
410057	5,0 m
410058	7,5 m
410059	10,0 m

### AES/EBU & DMX cables

#### XLR male ⇔ XLR female 5-pin, 3-pin assigned, HICON

##### Assignment: Screen on PIN 1, + on PIN 2, - on PIN 3

Part no.	Length
410065	2,5 m
410066	5,0 m
410067	10,0 m
410068	20,0 m

### AES/EBU & DMX cables

#### XLR male 3-pin ⇔ XLR female 5-pin, 3-pin assigned, Neutrik

##### Assignment: Screen on PIN 1, + on PIN 2, - on PIN 3

Part no.	Length
410074	0,1 m
410075	1,0 m
410076	2,5 m
410077	5,0 m

### AES/EBU & DMX 512

#### XLR male ⇔ XLR female 5-pin, fully assigned, HICON

Part no.	Length
410082	2,5 m
410083	5,0 m
410084	10,0 m
410085	20,0 m

### AES/EBU & DMX cables

#### XLR male ⇔ XLR female 3-pin, Neutrik

Part no.	Length
410060	2,5 m
410061	5,0 m
410062	10,0 m
410063	20,0 m
410064	50,0 m

### AES/EBU & DMX cables

#### XLR male ⇔ XLR female 5-pin, 3-pin assigned, Neutrik

##### Assignment: Screen on PIN 1, + on PIN 2, - on PIN 3

Part no.	Length
410069	2,5 m
410070	5,0 m
410071	10,0 m
410072	20,0 m
410073	50,0 m

### AES/EBU & DMX cables

#### XLR male 5-pin ⇔ XLR female 3-pin, 3-pin assigned, Neutrik

##### Assignment: Screen on PIN 1, + on PIN 2, - on PIN 3

Part no.	Length
410078	0,1 m
410079	1,0 m
410080	2,5 m
410081	5,0 m

### AES/EBU & DMX 512

#### XLR male ⇔ XLR female 5-pin, Neutrik

Part no.	Length
410086	2,5 m
410087	5,0 m
410088	10,0 m
410089	20,0 m
410090	50,0 m

Dimensions and specifications may be changed without prior notice.

# Speaker cable

Speaker cable preassembled



## Cable

Speaker cable, round, paired / multi-core

## Connector

XLR connector from Neutrik;  
Speakon connector from Neutrik or Amphenol

## Application

The pre-assembled HELUSOUND® speaker cable for professional media technology.

### Loudspeaker, round, paired

#### TWINAXIAL, XLR male ↔ XLR female, Neutrik

Part no.	Length
410091	1,0 m
410092	2,5 m
410093	5,0 m
410094	10,0 m
410095	15,0 m
410096	20,0 m

### Loudspeaker, round, paired

#### Speakon ↔ Speakon 2-pin, Neutrik

Part no.	Length
410104	1,0 m
410105	2,5 m
410106	5,0 m
410107	10,0 m
410108	15,0 m
410109	20,0 m
410110	25,0 m

### Loudspeaker, round, multicore

#### Neutrik NL4F, fully assigned, individual cores numbered

Part no.	Length
410118	1,0 m
410119	2,5 m
410120	5,0 m
410121	10,0 m
410122	15,0 m
410123	20,0 m
410124	25,0 m

### Loudspeaker, round, paired

#### Speakon ↔ Speakon 2-pin, Neutrik

Part no.	Length
410097	1,0 m
410098	2,5 m
410099	5,0 m
410100	10,0 m
410101	15,0 m
410102	20,0 m
410103	25,0 m

### Loudspeaker, round, multicore

#### Neutrik NL8FL, fully assigned, individual cores numbered

Part no.	Length
410125	5,0 m
410126	10,0 m
410127	15,0 m
410128	20,0 m
410129	25,0 m

### Loudspeaker, round, multicore

#### Amphenol EP8, fully assigned, individual cores numbered

Part no.	Length
410130	10,0 m
410131	15,0 m
410132	20,0 m
410133	25,0 m
410134	50,0 m

Dimensions and specifications may be changed without prior notice.



# Microphone cable

Microphone cable preassembled

HELUSOUND®



## Cable

Microphone cable 2x0,22, Part No. 400038

## Connector

HI-XCM3N-BLK connector or HI-XCF3N-BLK from HICON  
NC3MX or NC3FX from Neutrik

## Application

The pre-assembled HELUSOUND® microphone cable for professional use in media, radio and stage technology.

### Microphone cables

#### XLR male ↔ XLR female, HICON

##### Cables only in black

Part no.	Length
410135	1,0 m
410136	3,0 m
410137	6,0 m
410138	10,0 m
410139	15,0 m

### Microphone cables

#### XLR male ↔ XLR female, Neutrik

Part no.	Length
410140	0,5 m
410141	1,0 m
410142	2,5 m
410143	5,0 m
410144	7,5 m
410145	10,0 m
410146	15,0 m
410147	20,0 m

Dimensions and specifications may be changed without prior notice.

# Video cable

## Video cable, preassembled



### Cable

RG58 cable with bend protection sleeve 50 Ohm  
RG59 cable with bend protection sleeve 75 Ohm  
0,8/3,7 video patch cable

### Connector

BNC plug connectors from HICON  
HDTV-BNC video plug connector from Damar+Hagen

### Application

The pre-assembled video cable for professional use in media, radio and video technology.

#### RG 58

**BNC male ↔ BNC male 50 Ohm, HICON**

Part no.	Length
410148	0,25 m
410149	0,5 m
410150	0,75 m
410151	1,0 m
410152	2,0 m
410153	3,0 m
410154	5,0 m
410155	10,0 m

#### RG 59

**BNC male ↔ BNC male 75 Ohm, HICON**

Part no.	Length
410156	0,25 m
410157	0,5 m
410158	0,75 m
410159	1,0 m

#### RG 59

**BNC male ↔ BNC male 75 Ohm, HICON**

Part no.	Length
410160	2,0 m
410161	3,0 m
410162	5,0 m
410163	10,0 m

#### 0,8 / 3,7 Video patch cables

**HDTV BNC male ↔ HDTV BNC male, Damar+Hagen**

Part no.	Length
410164	0,25 m
410165	0,5 m
410166	0,75 m
410167	1,0 m
410168	2,0 m
410169	3,0 m
410170	5,0 m
410171	10,0 m

Dimensions and specifications may be changed without prior notice.

# Rubber cable reel

with HELUKAT® data cable



## Type

### Drum

Equipment:

### Plug

Push-On connector type 1:

Push-On connector type 2:

System type:

Pin assignment:

## Norms and standards

## Preferred types

## Rubber cable reel with HELUKAT® copper data cable

### Rubber

with supporting frame

RJ45 8/8 - jack

RJ45 8/8 - jack

office connector

1:1 acc. to TIA/EIA 568 B

Components of HELUKAT® CONNECTING SYSTEMS® to 155 MHz acc. Categorie 5E and to 600MHz acc. Categorie 6 (Link), ISO 11801 1st Edition, EN 50173-3 and EIA/TIA 568 B. Be in accordance with the Cat.5E respectively the Cat. 6 structured cabling.

Part no.	Designation	Sheath colour	Frequency MHz	Cable length m	Flame proof	Oil-resistant
802073	FTP 4x2xAWG24/1 PVC	Yellow similar to RAL 1021	155	50,0	-	-
802074	FTP 4x2xAWG24/1 PVC	Yellow similar to RAL 1021	155	90,0	-	-
802075	S-STP 4x2xAWG 23/1 FRNC	Blue Lilac similar to RAL 4005	600	50,0	acc. to IEC 60332-3	-
802076	S-STP 4x2xAWG 23/1 FRNC	Blue Lilac similar to RAL 4005	600	90,0	acc. to IEC 60332-3	-
802207	S-STP 4x2xAWG 23/1 PUR	Green similar to RAL 6018	600	50,0	acc. to IEC 60332-1	EN60811-2-1
802208	S-STP 4x2xAWG 23/1 PUR	Green similar to RAL 6018	600	90,0	acc. to IEC 60332-1	EN60811-2-1

Dimensions and specifications may be changed without prior notice.

## Characteristics

Rubber cable reel with RJ45 jacks and dust protection. Suitable for mobile use on site, for example for meetings, TV-Transmissions, Fairs, etc.. Everywhere when there is a need for a removable cable connection. Usable for fixed installation cabling.

# Rubber cable reel

with HELUCOM® fibre optic cable



## Type

## Rubber cable reel with HELUCOM® fibre optic mobile cable

### Drum

Equipment:

### Rubber

with supporting frame

### Cable

Description:  
sheath colour:

Fibre-optic cable, mobile, trailing  
Orange

Flame proof

VDE 0482-332-1-2

### Plug

System type:  
Protective grommet:  
APC version:

office connector  
Plugged  
no

## Norms and standards

Components of HELUCOM CONNECTING SYSTEMS® according actual standards. Meet the standard IEC 60794-1-2 F5 and E6. Also they realize the optical data acc. OM1, OM2 and ITU-T G.652.

## Preferred types

Part no.	Fibre category	Fibre count	Plug 1	Plug 2	Cable length m
<b>802223</b>	Multimode G50/125	4	ST	ST	500,0
<b>802226</b>	Multimode G62,5/125	4	ST	ST	500,0
<b>802229</b>	Single-Mode E9/125	4	ST	ST	500,0
<b>802224</b>	Multimode G50/125	4	SC duplex	SC duplex	500,0
<b>802227</b>	Multimode G62,5/125	4	SC duplex	SC duplex	500,0
<b>802230</b>	Single-Mode E9/125	4	SC duplex	SC duplex	500,0
<b>802225</b>	Multimode G50/125	4	LC duplex	LC duplex	500,0
<b>802228</b>	Multimode G62,5/125	4	LC duplex	LC duplex	500,0
<b>802231</b>	Single-Mode E9/125	4	LC duplex	LC duplex	500,0

Dimensions and specifications may be changed without prior notice.

## Characteristics

Rubber cable reel with 4 fibre optic jacks and fibre optic plugs. Suitable for mobile use on site, for example for meetings, TV-Transmissions, Fairs, etc.. Everywhere when there is a need for a removable cable connection. Usable for flexible and fixed installation cabling.

# HELUTEC-Star

preassembled on both sides with flexible JZ-500, numbered

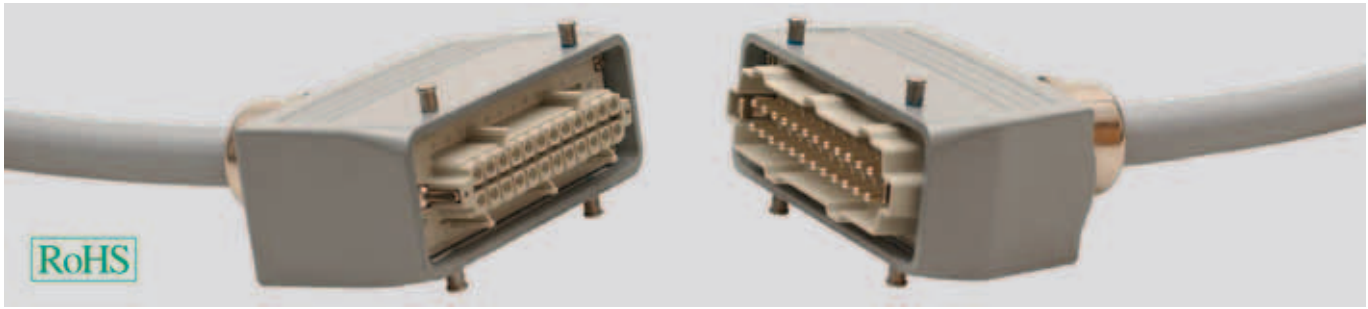

## Cable

HELUKABEL® JZ 500

## Connector

HELUTEC-Star

## Application

The pre-assembled HELUTEC-Star control cable for the professional Media, Broadcast and Stage Technic using.

Part no.	Wire	No. cores x cross-sec. mm <sup>2</sup>	Outer Ø app. mm	Length m	Plug 1	Plug 2
410000	10105	14 G 1,5	12,9	1,0	HELUTEC-STAR 16-pole M	HELUTEC-STAR 16-pole F
410001	10105	14 G 1,5	12,9	3,0	HELUTEC-STAR 16-pole M	HELUTEC-STAR 16-pole F
410002	10105	14 G 1,5	12,9	5,0	HELUTEC-STAR 16-pole M	HELUTEC-STAR 16-pole F
410003	10105	14 G 1,5	12,9	10,0	HELUTEC-STAR 16-pole M	HELUTEC-STAR 16-pole F
410004	10105	14 G 1,5	12,9	15,0	HELUTEC-STAR 16-pole M	HELUTEC-STAR 16-pole F
410005	10105	14 G 1,5	12,9	20,0	HELUTEC-STAR 16-pole M	HELUTEC-STAR 16-pole F
410006	10105	14 G 1,5	12,9	30,0	HELUTEC-STAR 16-pole M	HELUTEC-STAR 16-pole F

Part no.	Wire	No. cores x cross-sec. mm <sup>2</sup>	Outer Ø app. mm	Length m	Plug 1	Plug 2
410007	10107	18 G 1,5	14,5	1,0	HELUTEC-STAR 24-pole M	HELUTEC-STAR 24-pole F
410008	10107	18 G 1,5	14,5	3,0	HELUTEC-STAR 24-pole M	HELUTEC-STAR 24-pole F
410009	10107	18 G 1,5	14,5	5,0	HELUTEC-STAR 24-pole M	HELUTEC-STAR 24-pole F
410010	10107	18 G 1,5	14,5	10,0	HELUTEC-STAR 24-pole M	HELUTEC-STAR 24-pole F
410011	10107	18 G 1,5	14,5	15,0	HELUTEC-STAR 24-pole M	HELUTEC-STAR 24-pole F
410012	10107	18 G 1,5	14,5	20,0	HELUTEC-STAR 24-pole M	HELUTEC-STAR 24-pole F
410013	10107	18 G 1,5	14,5	30,0	HELUTEC-STAR 24-pole M	HELUTEC-STAR 24-pole F

Part no.	Wire	No. cores x cross-sec. mm <sup>2</sup>	Outer Ø app. mm	Length m	Plug 1	Plug 2
410014	10131	14 G 2,5	16,1	1,0	HELUTEC-STAR 16-pole M	HELUTEC-STAR 16-pole F
410015	10131	14 G 2,5	16,1	3,0	HELUTEC-STAR 16-pole M	HELUTEC-STAR 16-pole F
410016	10131	14 G 2,5	16,1	5,0	HELUTEC-STAR 16-pole M	HELUTEC-STAR 16-pole F
410017	10131	14 G 2,5	16,1	10,0	HELUTEC-STAR 16-pole M	HELUTEC-STAR 16-pole F
410018	10131	14 G 2,5	16,1	15,0	HELUTEC-STAR 16-pole M	HELUTEC-STAR 16-pole F
410019	10131	14 G 2,5	16,1	20,0	HELUTEC-STAR 16-pole M	HELUTEC-STAR 16-pole F
410020	10131	14 G 2,5	16,1	30,0	HELUTEC-STAR 16-pole M	HELUTEC-STAR 16-pole F

Part no.	Wire	No. cores x cross-sec. mm <sup>2</sup>	Outer Ø app. mm	Length m	Plug 1	Plug 2
410021	10132	18 G 2,5	18,1	1,0	HELUTEC-STAR 24-pole M	HELUTEC-STAR 24-pole F
410022	10132	18 G 2,5	18,1	3,0	HELUTEC-STAR 24-pole M	HELUTEC-STAR 24-pole F
410023	10132	18 G 2,5	18,1	5,0	HELUTEC-STAR 24-pole M	HELUTEC-STAR 24-pole F
410024	10132	18 G 2,5	18,1	10,0	HELUTEC-STAR 24-pole M	HELUTEC-STAR 24-pole F
410025	10132	18 G 2,5	18,1	15,0	HELUTEC-STAR 24-pole M	HELUTEC-STAR 24-pole F
410026	10132	18 G 2,5	18,1	20,0	HELUTEC-STAR 24-pole M	HELUTEC-STAR 24-pole F
410027	10132	18 G 2,5	18,1	30,0	HELUTEC-STAR 24-pole M	HELUTEC-STAR 24-pole F

Dimensions and specifications may be changed without prior notice.

# HELUTEC-Star

preassembled on both sides with flexible JZ-600, numbered



**Cable**

HELUKABEL® JZ 600

**Connector**

HELUTEC-Star

**Application**

The pre-assembled HELUTEC-Star control cable for the professional Media, Broadcast and Stage Technic using.

Part no.	Wire	No. cores x cross-sec. mm <sup>2</sup>	Outer Ø app. mm	Length m	Plug 1	Plug 2
410028	10672	14 G 1,5	17,4	1,0	HELUTEC-STAR 16-pole M	HELUTEC-STAR 16-pole F
410029	10672	14 G 1,5	17,4	3,0	HELUTEC-STAR 16-pole M	HELUTEC-STAR 16-pole F
410030	10672	14 G 1,5	17,4	5,0	HELUTEC-STAR 16-pole M	HELUTEC-STAR 16-pole F
410031	10672	14 G 1,5	17,4	10,0	HELUTEC-STAR 16-pole M	HELUTEC-STAR 16-pole F
410032	10672	14 G 1,5	17,4	15,0	HELUTEC-STAR 16-pole M	HELUTEC-STAR 16-pole F
410033	10672	14 G 1,5	17,4	20,0	HELUTEC-STAR 16-pole M	HELUTEC-STAR 16-pole F
410034	10672	14 G 1,5	17,4	30,0	HELUTEC-STAR 16-pole M	HELUTEC-STAR 16-pole F

Part no.	Wire	No. cores x cross-sec. mm <sup>2</sup>	Outer Ø app. mm	Length m	Plug 1	Plug 2
410035	10674	18 G 1,5	19,7	1,0	HELUTEC-STAR 24-pole M	HELUTEC-STAR 24-pole F
410036	10674	18 G 1,5	19,7	3,0	HELUTEC-STAR 24-pole M	HELUTEC-STAR 24-pole F
410037	10674	18 G 1,5	19,7	5,0	HELUTEC-STAR 24-pole M	HELUTEC-STAR 24-pole F
410038	10674	18 G 1,5	19,7	10,0	HELUTEC-STAR 24-pole M	HELUTEC-STAR 24-pole F
410039	10674	18 G 1,5	19,7	15,0	HELUTEC-STAR 24-pole M	HELUTEC-STAR 24-pole F
410040	10674	18 G 1,5	19,7	20,0	HELUTEC-STAR 24-pole M	HELUTEC-STAR 24-pole F
410041	10674	18 G 1,5	19,7	30,0	HELUTEC-STAR 24-pole M	HELUTEC-STAR 24-pole F

Part no.	Wire	No. cores x cross-sec. mm <sup>2</sup>	Outer Ø app. mm	Length m	Plug 1	Plug 2
410042	10700	14 G 2,5	19,6	1,0	HELUTEC-STAR 16-pole M	HELUTEC-STAR 16-pole F
410043	10700	14 G 2,5	19,6	3,0	HELUTEC-STAR 16-pole M	HELUTEC-STAR 16-pole F
410044	10700	14 G 2,5	19,6	5,0	HELUTEC-STAR 16-pole M	HELUTEC-STAR 16-pole F
410045	10700	14 G 2,5	19,6	10,0	HELUTEC-STAR 16-pole M	HELUTEC-STAR 16-pole F
410046	10700	14 G 2,5	19,6	15,0	HELUTEC-STAR 16-pole M	HELUTEC-STAR 16-pole F
410047	10700	14 G 2,5	19,6	20,0	HELUTEC-STAR 16-pole M	HELUTEC-STAR 16-pole F
410048	10700	14 G 2,5	19,6	30,0	HELUTEC-STAR 16-pole M	HELUTEC-STAR 16-pole F

Part no.	Wire	No. cores x cross-sec. mm <sup>2</sup>	Outer Ø app. mm	Length m	Plug 1	Plug 2
410049	10701	18 G 2,5	22,0	1,0	HELUTEC-STAR 24-pole M	HELUTEC-STAR 24-pole F
410050	10701	18 G 2,5	22,0	3,0	HELUTEC-STAR 24-pole M	HELUTEC-STAR 24-pole F
410051	10701	18 G 2,5	22,0	5,0	HELUTEC-STAR 24-pole M	HELUTEC-STAR 24-pole F
410052	10701	18 G 2,5	22,0	10,0	HELUTEC-STAR 24-pole M	HELUTEC-STAR 24-pole F
410053	10701	18 G 2,5	22,0	15,0	HELUTEC-STAR 24-pole M	HELUTEC-STAR 24-pole F
410054	10701	18 G 2,5	22,0	20,0	HELUTEC-STAR 24-pole M	HELUTEC-STAR 24-pole F
410055	10701	18 G 2,5	22,0	30,0	HELUTEC-STAR 24-pole M	HELUTEC-STAR 24-pole F

Dimensions and specifications may be changed without prior notice.





**SELECTION TABLE - Cables in drag chains**

Index

Part no.	Page	Part no.	Page
11494	60	12326	65
11495 - 11497	52	12345 - 12371	378
11498	60	12372 - 12405	378
11499 - 11500	52	12410 - 12436	378
11501	60	12437 - 12470	378
11502	52	12471 - 12517	384
11519	60	12518 - 12543	385
	52	12550 - 12670	388
	60	12680 - 12671	430
	52	12723 - 12746	**
	60	12747 - 12804	
		12805 - 12845	
		12850 - 12877	10
		12907	101
			426
			435



**SELECTION TABLE - CABLES & WIRES**

Part no.	Page	Part no.	Page
11503	60	12805	10
11504	52	12850	10
11505	60	12877	101
11506	52	12907	101
11507	60		
11508	52		
11509	60		
11510	52		
11511	60		
11512	52		
11513	60		
11514	52		
11515	60		
11516	52		
11517	60		
11518	52		
11519	60		
11520	52		
11521	60		
11522	52		
11523	60		
11524	52		
11525	60		
11526	52		
11527	60		
11528	52		
11529	60		
11530	52		
11531	60		
11532	52		
11533	60		
11534	52		
11535	60		
11536	52		
11537	60		
11538	52		
11539	60		
11540	52		
11541	60		
11542	52		
11543	60		
11544	52		
11545	60		
11546	52		
11547	60		
11548	52		
11549	60		
11550	52		
11551	60		
11552	52		
11553	60		
11554	52		
11555	60		
11556	52		
11557	60		
11558	52		
11559	60		
11560	52		
11561	60		
11562	52		
11563	60		
11564	52		
11565	60		
11566	52		
11567	60		
11568	52		
11569	60		
11570	52		
11571	60		
11572	52		
11573	60		
11574	52		
11575	60		
11576	52		
11577	60		
11578	52		
11579	60		
11580	52		
11581	60		
11582	52		
11583	60		
11584	52		
11585	60		
11586	52		
11587	60		
11588	52		
11589	60		
11590	52		
11591	60		
11592	52		
11593	60		
11594	52		
11595	60		
11596	52		
11597	60		
11598	52		
11599	60		
11600	52		



**Questionnaire for energy drag chains**

Company: \_\_\_\_\_

First name, Name: \_\_\_\_\_

Street, No: \_\_\_\_\_

Postal Code, Place: \_\_\_\_\_

Phone / Fax: \_\_\_\_\_

E-Mail: \_\_\_\_\_

Installation site: \_\_\_\_\_

Kind of machine: \_\_\_\_\_

Installation size: \_\_\_\_\_

Sender: \_\_\_\_\_

**1. Drag Chain-Parameter**

1. Chain length/chain width: \_\_\_\_\_ m/mm

2. Chain pitch: \_\_\_\_\_ mm

3. Bending radius: \_\_\_\_\_ mm

4. Guide stays existing:  Yes  No

5. Frame stays existing:  Yes  No

6. Layout/Installation:  Horizontal  Vertical

**2. Installation and Movement-Parameter**

1. Movement distance (max.): \_\_\_\_\_ m

2. Speeds: \_\_\_\_\_ m/s

3. Acceleration: \_\_\_\_\_ m/s<sup>2</sup>

4. Frequency per time unit: \_\_\_\_\_ c/h

5. Average movement distance/cycle: \_\_\_\_\_ m

6. Daily working duration: \_\_\_\_\_ h

7. Feeding at mid of moving distance:  Yes  No

8. Additional weight/chain: \_\_\_\_\_ kg

**3. Cable-Parameter**

1. Cable length (max.): \_\_\_\_\_

**Enquiry Special Cable**

Phone: +49 7150 9209-0  
 Fax: +49 7150 81786  
 E-Mail: anfrage-spezialkabel@helukabel.de

Enquiry: \_\_\_\_\_

Yearly requirement approx: \_\_\_\_\_

Delivery required: \_\_\_\_\_

Size: \_\_\_\_\_

Application:  indoor  outdoor  for flexing  with reversed bending

stationary  Drag chain  speed \_\_\_\_\_ m/s  Acceleration \_\_\_\_\_ m/s<sup>2</sup>

load \_\_\_\_\_  cyclic  non-cyclic  continuous \_\_\_\_\_ °C

Temperatures: ambient \_\_\_\_\_ °C



## ■ TECHNICAL INFORMATION

<b>Designation</b>	<b>Page</b>
Characteristics of insulating and sheath materials	<b>94</b>
AWG wires	<b>96</b>
Copper calculations	<b>98</b>
Fire performance and fire propagation	<b>99</b>
Glossary	<b>100</b>
Order form	<b>104</b>
Part number index	<b>105</b>
Notes	<b>106</b>

# CHARACTERISTICS\* OF INSULATING AND SHEATH MATERIALS

Designation			Electrical					Thermic								
			Density g/m <sup>3</sup>	Break-down-voltage- KV/mm (20°C)	Specific volume resistivity Ohm · cm 20°C	Dielectric constant 50 Hz/20°C	Dielectric loss-factor tan δ	Working temperature		Melt-temperature +°C	Flame-resistance	Oxygen index LOI (% O <sub>2</sub> )	Heating value H <sub>0</sub> MU · kg <sup>-1</sup>			
VDE Initial-code	Ab- brevi- ations	Materials						permanent °C	short time °C							
Thermoplastic	Y	PVC	Polyvinylchloride compounds	1,35–1,5	25	10 <sup>13</sup> –10 <sup>15</sup>	3,6–6	4 x 10 <sup>-2</sup> to 1 x 10 <sup>-1</sup>	- 30 + 70	+100	>140	self-extin- guishing	23–42	17–25		
	Yw	PVC	Heat-resistant 90°C	1,3–1,5	25	10 <sup>12</sup> –10 <sup>15</sup>	4–6,5		- 20 + 90	+120	>140		16–22			
	Yw	PVC	Heat-resistant 105°C	1,3–1,5	25	10 <sup>12</sup> –10 <sup>15</sup>	4,5–6,5		- 20 +105	+120	>140		24–42	16–20		
	Yk	PVC	Cold resistant	1,2–1,4	25	10 <sup>12</sup> –10 <sup>15</sup>	4,5–6,5		- 40 + 70	+100	>140		17–24			
	2Y	LDPE	Low density Polyethylene	0,92–0,94	70	10 <sup>17</sup>	2,3	2 x 10 <sup>-4</sup>	- 50 + 70	+100	105–110	flammable	≅22	42–44		
	2Y	HDPE	High density Polyethylene	0,94–0,98	85	10 <sup>17</sup>	2,3	3 x 10 <sup>-4</sup>	- 50 +100	+120	130					
	2X	VPE	Cross-linked Polyethylene	0,92	50	10 <sup>12</sup> –10 <sup>16</sup>	4–6	2 x 10 <sup>-3</sup>	- 35 + 90	+100	-					
	O2Y		Foamed Polyethylene	~0,65	30	10 <sup>17</sup>	~1,55	5 x 10 <sup>-4</sup>	- 40 + 70	+100	105				18–30	
	3Y	PS	Polystrole	1,05	30	10 <sup>16</sup>	2,5	1 x 10 <sup>-4</sup>	- 50 + 80	+100	>120				≅22	40–43
	4Y	PA	Polyamide	1,02–1,1	30	10 <sup>15</sup>	4	2 x 10 <sup>-2</sup> bis 1 x 10 <sup>-3</sup>	- 60 +105	+125	210				≅22	27–31
	9Y	PP	Polypropylene	0,91	75	10 <sup>16</sup>	2,3–2,4	4 x 10 <sup>-4</sup>	- 10 +140	+140	160				42–44	
	11Y	PUR	Polyurethane	1,15–1,2	20	10 <sup>10</sup> –10 <sup>12</sup>	4–7	2,3 x 10 <sup>-2</sup>	- 55 + 80	+100	150				20–26	20–26
	TPE-E (12Y)		Polyester Elastomer	1,2–1,4	40	>10 <sup>10</sup>	3,7–5,1	1,8 x 10 <sup>-2</sup>	- 50 +100	+140	190				≅29	20–25
TPE-O		Polyolefine Elastomer	0,89–1,0	30	>10 <sup>14</sup>	2,7–3,6	+130		150	≅25	23–28					
Elastomere	G	NR SBR	Natural rubber Styrol-butadiene- rubber-compounds	1,5–1,7	20	10 <sup>12</sup> –10 <sup>15</sup>	3–5	1,9 x 10 <sup>-2</sup>	- 65 + 60	+120	-	flammable	≅22	21–25		
	2G	SiR	Silicone rubber	1,2–1,3	20	10 <sup>15</sup>	3–4	6 x 10 <sup>-3</sup>	- 60 +180	+260	-	high flash point	25–35	17–19		
	3G	EPR	Ethylen-propylene rubber-compounds	1,3–1,55	20	10 <sup>14</sup>	3–3,8	3,4 x 10 <sup>-3</sup>	- 30 + 90	+160	-	flammable	≅22	21–25		
	4G	EVA	Ethylen-vinylacetat copolymer-compounds	1,3–1,5	30	10 <sup>12</sup>	5–6,5	2 x 10 <sup>-2</sup>	- 30 +125	+200	-		19–23			
	5G	CR	Polychloroprene compounds	1,4–1,65	20	10 <sup>10</sup>	6–8,5	5 x 10 <sup>-2</sup>	- 40 +100	+140	-	self-extin- guishing	30–35	14–19		
	6G	CSM	Chlorsulfonated Polyethylene compounds	1,3–1,6	25	10 <sup>12</sup>	6–9	2,8 x 10 <sup>-2</sup>	- 30 + 80	+140	+160		19–23			
High temp. materials	10Y	PVDF	Polyvinylidene fluoride Kynar/Dyflor	1,7–1,9	25	10 <sup>14</sup>	9–7	1,4 x 10 <sup>-2</sup>	- 40 +135	+160	>170	self-extin- guishing	40–45	15		
	7Y	ETFE	Ethylene-Tetrafluor ethylene	1,6–1,8	36	10 <sup>16</sup>	2,6	8 x 10 <sup>-4</sup>	-100 +150	+180	>265	self-extin- guishing	30–35	14		
	6Y	FEP	Fluorine ethylene propylene	2,0–2,3	25	10 <sup>18</sup>	2,1	3 x 10 <sup>-4</sup>	-100 +205	+230	>225	self-extin- guishing	>95	5		
	5YX	PFA	Perfluoralkoxy-polymeric	2,0–2,3	25	10 <sup>18</sup>	2,1	3 x 10 <sup>-4</sup>	-190 +260	+280	>290	self-extin- guishing	>95	5		
	5Y	PTFE	Polytetrafluorethylene	2,0–2,3	20	10 <sup>18</sup>	2,1	3 x 10 <sup>-4</sup>	-190 +260	+300	>325	self-extin- guishing	>95	5		
halogen-free compounds	H	not cross- linked	halogen-free polymer-compounds	1,4–1,6	25	10 <sup>12</sup> –10 <sup>14</sup>	3,4–5	~10 <sup>-3</sup>	- 30 + 70	+100	>130	self-extin- guishing	≅40	17–22		
	HX	cross- linked	halogen-free polymer-compounds	1,4–1,6	25	10 <sup>13</sup> –10 <sup>14</sup>	3,4–5	10 <sup>-2</sup> –10 <sup>-3</sup>	- 30 + 90	+150	-	self-extin- guishing	≅40	16–25		

\* The characteristics valid for unprocessed material

# CHARACTERISTICS\* OF INSULATING AND SHEATH MATERIALS

Thermic		Mechanical						Halogen	Weather		Designation										
Thermal-conductivity W·K <sup>-1</sup> ·m <sup>-1</sup>	Corrosive gases in case of fire	Radiation-resistance-max Mrad	tensile strength N/mm <sup>2</sup>	Elongation at break %	Shore-hardness	Abriebverhalten	Abrasion resistance	halogen-free	Weather resistance	Cold resistance	VDE-Initial-code	Abbre- viat- ions	Material								
0,17	Hydrogen chloride	80	10-25	130-350	70-95 (A)	medium	0,4	no	medium in black	moderate-good	Y	PVC	Polyvinylchloride-compounds								
											Yw	PVC	Heat-resistant 90°C								
											Yw	PVC	Heat-resistant 105°C								
	no	100	10-20	400-600	43-50 (D)	medium	0,1	yes		good	2Y	LDPE	Low density Polyethylene								
											2Y	HDPE	High density Polyethylene								
										0,3	12,5-20	300-400	40-45 (D)	medium	-	-	conditional <sup>1)</sup>	-	2X	VPE	Cross-linked Polyethylene
																			O2Y		Foamed Polyethylene
	0,25	no	80	55-65	300-400	35-50 (D)	good	0,4		medium-good	moderate-good	3Y	PS	Polystrole							
	0,23	no	10	50-60	50-170	-	very good	1,0-1,5		yes	good	good	4Y	PA	Polyamide						
	0,19												20-35	300	55-60 (D)	medium	0,1	moderate	9Y	PP	Polypropylene
0,25	100 (500)								30-45		500-700	70-100 (A)	very good	1,5	yes <sup>2)</sup>	very good	very good	11Y	PUR	Polyurethane	
0,5	10								30		>300	85 (A) 70 (D)	good	1,5	yes			TPE-E (12Y)	Polyester Elastomer		
1,5	10								20		55 (A) 70 (D)	TPE-O						Polyolefine Elastomer			
-	no	100	5-10	300-600	60-70 (A)	moderate	1,0	yes	moderate	very good	G	NR SBR	Natural rubber Styrol-butadiene-rubber-compounds								
											0,22	50	40-80 (A)	good	2G	SiR	Silicone rubber				
											-	200	200-400	65-85 (A)	very good	3G	EPR	Ethylene-Propylene rubber-compounds			
											-	100	8-12	250-350	70-80 (A)	good	4G	EVA	Ethylene-vinylacetat copolymer-compounds		
	-	Hydrogen chloride	50	10-20	400-700	55-70 (A)	medium	1,5		no	very good	5G	CR	Polychloroprene compounds							
	-											350-600	60-70 (A)	moderate	6G	CSM	Chlorsulfonated Polyethylene compounds				
0,17	Hydro-fluoric	10	50-80	150	75-80 (D)	very good	0,01	no	very good	very good	10Y	PVDF	Polyvinylidene fluoride Kynar/Dyflor								
	0,24	yes	10	40-50	150	70-75 (D)	very good				0,02	7Y	ETFE	Ethylene-Tetrafluor ethylene							
	0,26	yes	1	15-25	250	55-60 (D)	very good				0,01	6Y	FEP	Fluorine ethylene propylene							
	0,21	yes	0,1	25-30	250	55-60 (D)	very good				0,01	5YX	PFA	Perfluoralkoxy polymeric							
	0,26	yes	0,1	80	50	55-60 (D)	very good				0,01	5Y	PTFE	Polytetrafluorethylene							
0,17	no	100	8-13	150-250	65-95 (A)	medium	0,2-1,5	yes	medium in black: good	average	H	not cross-linked	halogen-free polymer-compounds								
	0,20	no	200	8-13		150-250					medium	HX	cross-linked	halogen-free polymer-compounds							

Thermoplastic

Elastomere

High temp. materials

halogen-free compounds

<sup>1)</sup> The propellant may be e.g. Fluor-Chlor-Hydrcarbon

<sup>2)</sup> depend on the type compound

## ■ AWG-WIRES & AWG-STRANDED CONDUCTORS

AWG No.	AWG- make-up n x AWG	conductor make-up Ø x mm	cross- section mm <sup>2</sup>	conductor outer-Ø mm	conductor resistance Ohm/km	conductor weight kg/km
36	solid	solid	0,013	0,127	1460,0	0,116
36	7/44	7x0,05	0,014	0,152	1271,0	0,125
34	solid	solid	0,020	0,160	918,0	0,178
34	7/42	7x0,05	0,022	0,192	777,0	0,196
32	solid	solid	0,032	0,203	571,0	0,284
32	7/40	7x0,078	0,034	0,203	538,0	0,302
32	19/44	19x0,05	0,037	0,229	448,0	0,329
30	solid	solid	0,051	0,254	365,0	0,45
30	7/38	7x0,102	0,057	0,305	339,0	0,507
30	19/42	19x0,064	0,061	0,305	286,7	0,543
28	solid	solid	0,080	0,330	232,0	0,71
28	7/36	7x0,127	0,087	0,381	213,0	0,774
28	19/40	19x0,078	0,091	0,406	186,0	0,81
27	7/35	7x0,142	0,111	0,457	179,0	0,988
26	solid	solid	0,128	0,409	143,0	1,14
26	10/36	10x0,127	0,127	0,533	137,0	1,13
26	19/38	19x0,102	0,155	0,508	113,0	1,38
26	7/34	7x0,160	0,141	0,483	122,0	1,25
24	solid	solid	0,205	0,511	89,4	1,82
24	7/32	7x0,203	0,227	0,610	76,4	2,02
24	10/34	10x0,160	0,201	0,582	85,6	1,79
24	19/36	19x0,127	0,241	0,610	69,2	2,14
24	41/40	41x0,078	0,196	0,582	84,0	1,74
22	solid	solid	0,324	0,643	55,3	2,88
22	7/30	7x0,254	0,355	0,762	48,4	3,16
22	19/34	19x0,160	0,382	0,787	45,1	3,4
22	26/36	26x0,127	0,330	0,762	52,3	2,94
20	solid	solid	0,519	0,813	34,6	4,61
20	7/28	7x0,320	0,562	0,965	33,8	5,0
20	10/30	10x0,254	0,507	0,889	33,9	4,51
20	19/32	19x0,203	0,615	0,940	28,3	5,47
20	26/34	26x0,160	0,523	0,914	33,0	4,65
20	41/36	41x0,127	0,520	0,914	32,9	4,63
18	solid	solid	0,823	1,020	21,8	7,32
18	7/26	7x0,404	0,897	1,219	19,2	7,98
18	16/30	16x0,254	0,811	1,194	21,3	7,22
18	19/30	19x0,254	0,963	1,245	17,9	8,57
18	41/34	41x0,160	0,824	1,194	20,9	7,33
18	65/36	65x0,127	0,823	1,194	21,0	7,32
16	solid	solid	1,310	1,290	13,7	11,66
16	7/24	7x0,511	1,440	1,524	12,0	12,81
16	65/34	65x0,160	1,310	1,499	13,2	11,65
16	26/30	26x0,254	1,317	1,499	13,1	11,72
16	19/29	19x0,287	1,229	1,473	14,0	10,94
16	105/36	105x0,127	1,330	1,499	13,1	11,84
14	solid	solid	2,080	1,630	8,6	18,51
14	7/22	7x0,643	2,238	1,854	7,6	19,92
14	19/27	19x0,361	1,945	1,854	8,9	17,31
14	41/30	41x0,254	2,078	1,854	8,3	18,49
14	105/34	105x0,160	2,111	1,854	8,2	18,79



# ■ AWG-WIRES & AWG-STRANDED CONDUCTORS

AWG No.	AWG-make-up n x AWG	conductor make-up Ø x mm	cross- section mm <sup>2</sup>	conductor outer-Ø mm	conductor resistance Ohm/km	conductor weight kg/km
12	solid	solid	3,31	2,05	5,4	29,46
12	7/20	7x0,813	3,63	2,438	4,8	32,30
12	19/25	19x0,455	3,09	2,369	5,6	27,50
12	65/30	65x0,254	3,292	2,413	5,7	29,29
12	165/34	165x0,160	3,316	2,413	5,2	29,51
10	solid	solid	5,26	2,59	3,4	46,81
10	37/26	37x0,404	4,74	2,92	3,6	42,18
10	49/27	49x0,363	5,068	2,946	3,6	45,10
10	105/30	105x0,254	5,317	2,946	3,2	47,32
8	49/25	49x0,455	7,963	3,734	2,2	70,87
8	133/29	133x0,287	8,604	3,734	2,0	76,57
8	655/36	655x0,127	8,297	3,734	2,0	73,84
6	133/27	133x0,363	13,764	4,676	1,5	122,49
6	259/30	259x0,254	13,123	4,674	1,3	116,79
6	1050/36	1050x0,127	13,316	4,674	1,3	118,51
4	133/25	133x0,455	21,625	5,898	0,80	192,46
4	259/27	259x0,363	26,804	5,898	0,66	238,55
4	1666/36	1666x0,127	21,104	5,898	0,82	187,82
2	133/23	133x0,574	34,416	7,417	0,50	306,30
2	259/26	259x0,404	33,201	7,417	0,52	295,49
2	665/30	665x0,254	33,696	7,417	0,52	299,89
2	2646/36	2646x0,127	33,518	7,417	0,52	298,31
1	133/22	133x0,643	43,187	8,331	0,40	384,37
1	259/25	259x0,455	42,112	8,331	0,41	374,80
1	817/30	817x0,254	41,397	8,331	0,42	368,43
1	2109/34	2109,160	42,403	8,331	0,41	377,39
1/0	133/21	1330,724	54,75	9,347	0,31	487,28
1/0	259/24	2590,511	53,116	9,347	0,32	472,73
2/0	133/20	1330,813	69,043	10,516	0,25	614,48
2/0	259/23	2590,574	67,021	10,516	0,25	596,49
3/0	259/22	2590,643	84,102	11,786	0,20	748,51
3/0	427/24	4270,511	87,570	11,786	0,19	779,37
4/0	259/21	2590,724	106,626	13,259	0,16	948,97
4/0	427/23	4270,574	110,494	13,259	0,15	983,39

## AWG-Wire (Solid-conductor)

AWG No.	Wire-Ø mm
44	0,050
41	0,070
40	0,079
39	0,089
38	0,102
37	0,114
36	0,127
35	0,142
34	0,160
33	0,180
32	0,203
31	0,226
30	0,254
29	0,287

AWG No.	Wire-Ø mm
28	0,320
27	0,363
26	0,404
25	0,455
24	0,511
23	0,574
22	0,643
21	0,724
20	0,813
19	0,912
18	1,024
17	1,151
16	1,290
15	1,450

AWG No.	Wire-Ø mm
14	1,628
13	1,829
12	2,052
11	2,304
10	2,588
,9	2,906
,8	3,268
,7	3,665
,6	4,115
,5	4,620
,4	5,189
,3	5,827
,2	6,543
,1	7,348

AWG No.	Wire-Ø mm
1/0	8,252
2/0	9,266
3/0	10,404
4/0	11,684



## ■ FIRE PERFORMANCE & FIRE PROPAGATION

European standards EN 50167, EN 50168, and EN 50169, require not only data lines with shielding, they also require data lines with halogen-free sheathing. Consideration and compliance with these standards is particularly recommended for public facilities such as hospitals, schools, and airports. We also recommend the use of halogen-free cable for buildings with high concentration of personnel or material assets.

### Cable with PVC sheath

If there is a fire, standard PVC material can propagate fires and form hydrochloric acid through the liberation of hydrogen chloride gas (HCl) in combination with moisture (e.g. water for fire fighting). In addition, burning PVC (polyvinyl chloride) produces high smoke density and the corrosive damage to buildings and equipment can often assume devastating proportions that far exceed the actual fire damage. HELUKAT® data lines are manufactured in accordance with IEC 60332-1 relative to fire propagation behaviour.

### Cable with halogen-free sheath

Here materials are used that do not contain halogens (such as chloride) and that do not release corrosive gases in the event of fire. The portion of toxic gases is also reduced to a minimum, and smoke density and fire propagation are hardly present or possible. Markings on the cable include the abbreviations FRNC or LSOH. These markings specifically refer to the following:

- FR** flame retardant (inhibits fire propagation)
- NC** non-corrosive (no corrosive components)
- LS** low smoke (low smoke density)
- OH** zero halogen (halogen-free)

For safety, when using such materials, it is essential that the view of passageways and emergency exits remains unobstructed. For this, however, it is necessary to also consider the use of such materials for other products such as power cables or cable guide channels. In terms of fire propagation behaviour, HELUKAT® data lines are manufactured in accordance with IEC 60332-1 or in accordance with the more rigorous IEC 60332-3.

### Caloric load [kWh/m] [MJ/m]

There is a wide variety of different combustible fixtures or products in every building. These include (even if concealed in suspended ceilings or channels) cables and lines that can represent a significant part of the facility, particularly in commercial premises. These cables have different energies (heating values) and they can significantly increase the total caloric value of a building. Consequently, in the planning stage ensure that caloric value quantities are kept as low as possible.

### Test methods for fire propagation

The verification or definition of how effectively or how well cable must counter fire propagation and thus the spread of the fire is specified in the standards IEC 60332-1, IEC 60332-2 and IEC 60332-3. For test method 1, a 50 cm long cable is exposed to flame from a gas burner for 1 minute, and must then extinguish any flame on its own, and it may be burned up to a maximum of 5 cm under the upper clamp. For test method 3, an entire bundle of cable, 3.5 m long is mounted vertically on a ladder in a cabinet and exposed to flame for 20 minutes. After turning off the gas burner, the flame must extinguish on its own within 1 hour and the distance between burner and the fire damage on the cables furthest removed from the burner must not exceed 2.5 m.

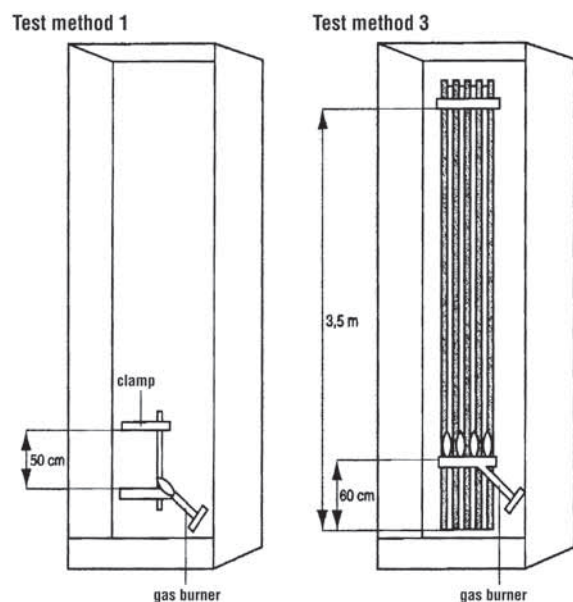

**This test is a very realistic representation of a possible fire in a cabling chute.**

# ■ GLOSSARY

## **AES/EBU**

Informal name of a digital audio standard jointly created by the AES (Audio Engineering Society) and the EBU (European Broadcasting Union). The standard specifies the transmission properties of the digital signal in order to simplify the communication between the devices. The connecting cable is used for the transmission of digital stereo, dual-channel or mono audio signals. Primarily used in professional sound studios. The right plug connector for coaxial cables is BNC. XLR connector plugs are used for symmetrical cables.

## **Analogue**

The analogue signal is a physically measurable variable (such as a voltage), which can be modified in terms of frequency and amplitude and is used to transmit information. Analogue cables transmit analogue signals in the low frequency range. They are required in the audio sector for connecting instruments, microphones, loudspeakers and other components.

## **ATM**

Asynchronous Transfer Mode. Based on cells of 53 bytes. Suitable for telephone, video and other data transmission. Mainly used in WAN applications.

## **Attenuation**

Reduction of the signal output between two cross section areas of a fibre. It is dependent on the wavelength: Main causes: Dispersion, absorption. Its unit of measure is "dB", specified as  $10 \log P(L1)/P(L2)$ .

## **Attenuation coefficient**

This is the attenuation of the cable in relation to the length in stationary condition (unit: dB/km or dB/100).

## **AWG**

American Wire Gauge, a unit for wire diameter.

## **BNC connector**

The name is based on the names of the inventors of the bayonet nut connector: Neill and Concelman. Used in radio, video, medicine and computer technology.

## **Broadband cable distributor network**

The broadband cable distributor network is used on the basis of coaxial cables, e.g. for cable television in the frequency range of 47 MHz to 446 MHz.

## **BUS**

A network topology which is characterised by a single cable that leads to all workstations.

## **Bus system**

The bus system is a system of cables for informatics, which is used to transmit information and data.

## **Cable**

Means of transferring signals. This consists of one or several electric conductors insulated from each other in a common sleeve installed in the cable covering.

## **Cable shield**

Conductive sleeve of a cable or a conductor for protecting individual cores or the complete stranded elements against outside electromagnetic influences.

## **Cable core**

The total complement of stranded elements present in the cable and the wrapping over all these elements.

## **Cable covering**

The cable sheath, generally made of polyethylene (PE), polyvinyl chloride (PVC) or halogen-free material (H) which protects the cable core from environmental influences.

## **CATV**

Community Antenna Television (International).

## **CATV cables**

CATV cables are primarily used for television distribution but they can also be used for all other transmissions up to 1 GHz. The inner conductor is made of copper with PE discs used as spacers for the cavity-type insulation that is primarily used. The outer conductor, which is formed from a copper band into a closed tube, is coated with a black UV-resistant PE jacket.

## **CEE**

International Commission on Rules for the Approval of Electrical Equipment.

## **CENELEC**

Comité Européen de Normalisation Electrotechnique (European Committee for Electrical Engineering Standardisation) Responsible for the harmonisation of electrical engineering standards in the European Union.

## **Cinch connector**

The term "cinch connector" describes a connector plug for 2-core cables. They have been distributed worldwide in HiFi devices that were originally built in Asia.

## **Coaxial cable**

Concentric conductor pair, consisting of an inside conductor and an outside conductor which completely encloses the inside conductor. The inside conductor and outside conductor are insulated from each other with a homogenous material or a combination of fixed supporting shells and a gas.

## **Compact fibre**

A combination of single fibre loose buffer and tight buffered cable. The small hollow space between the fibre and sheathing is filled with a non-stick coating.

## **Conductor**

Conductors are used for forwarding the electrical carriers and thus consist of an electrically conductive material (metal). Conductors are usually round.

## **Conductor resistance**

The conductor resistance is determined by the quality of the copper used and of the conductor cross-section. It increases linearly with the length of the cable and is a key factor in determining the attenuation.

## **Corrosivity**

Produced by corrosive gases and acids when burning cables and wires. Non-corrosive cables should be used when laying cables in buildings. Halogen-free cables are generally non-corrosive.

## **Coupling**

Due to the spatial layout of the telecom cables, electrical influences occur between the voice circuits (the couplings). The effect of these is crosstalk.

## **Coupling resistance**

Measurement for the quality of the shielding. It is defined as the ratio of the voltage along the shield of the disturbed system to the current of the interfering system.

## **Crimping**

Crimping is a physical connecting technique. This involves sliding a metal sleeve over the shielding and squeezing it together using crimping pliers, e.g. for connecting coaxial connectors to a coaxial cable.

## **Crimping**

A mechanical protection is made by pressing a sleeve around the fibres.

## **Crosstalk**

Undesired transfer of energy, e.g. between two neighbouring fibres of a cable.

## **Decibel**

Decibel=dB. A decibel is a dimensionless numerical proportion. It is the tenth part of the bel and is the unit of measure for attenuation.

## **Digital/analogue converter**

Functional unit which converts a digital signal to an analogue signal.

## **Digital signal**

A digital signal has several information parameters, e.g. 8, 16, 32 or 64, which are provided one after the other chronologically for serial signals and in parallel chronologically for parallel signals. The 1/0 coded representation of information such as digits and letters or the bit patterns from analogue signals (sounds, images, videos, measurement values etc) produced by scanning and quantisation. In media technology, digital signals are transmitted in the AES/EBU, S/P-DIF and DMX standard by means of digital cables. The digital cable connects scanners, lighting control panels, studio equipment or other HiFi components.

## **DMX cable (Digital Multiplex)**

This is used in lighting technology for controlling dimmers, floodlights and effect units.

## **Earth conductor**

Conductor which connects the body of an apparatus to be earthed with an earth connector or several earth connectors, provided this conductor is insulated in the earth or laid outside it.

## **Electromagnetic interference**

Irradiation of interference during signal transmission caused by electro-magnetic fields.

## **EMC**

Electromagnetic compatibility is the ability of an electric apparatus to operate satisfactorily in its electromagnetic environment without abnormally influencing this environment (which also includes other equipment) or itself being influenced by it.

# GLOSSARY

## **EMC directives, general**

Basic requirements for electromagnetic compatibility are specified in this new EMC Directive which equipment must comply with so that it can be placed on the market and put into service. "Equipment" is the higher-level concept for the objects included in the Directive, which on the one hand are "devices" and on the other hand "stationary systems". For the purposes of the Directive, equipment also means components and assemblies installed in a device by the end user and mobile systems, which are defined as a combination of devices and other components which can be operated at various locations. Stationary systems in the new EMC Directive also include large machines, high-voltage systems, electricity grids and telecommunications networks. These must be designed according to the recognised technology regulations, however do not require a conformity assessment before being put into service.

## **Face coupling** (star surface coupling)

Signal transfer via fibre ends connected at the front.

## **FDDI (Fibre Distributed Data Interface)**

Fibre optic network with dual opposite ring topology and 100 Mbit/s transfer rate. The FDDI is fault tolerant to cable or node failure.

## **Fibre multiplex**

Transmission method where one fibre is assigned to each transmission channel.

## **Fibre optics**

Transparent dielectric waveguide for transferring electromagnetic waves in the visible light range. The conductors are made of glass fibre or plastic fibre and are not sensitive to electromagnetic interference.

## **Flame retardant**

Description of the behaviour of products against fire propagation

## **Frequency**

Number of complete oscillations per second (in Hz).

## **FRNC**

FR=flame retardant and NC=non corrosive.

## **Halogen-free**

No halides (e.g. chlorine) in use. Halogen-free cables are used for increased fire protection requirements (in public buildings) with respect to protection of persons or on account of high material concentration. In the event of a fire, they do not release any corrosive gases and the quantity of toxic gases that is released is significantly lower than for PVC materials.

## **High frequency**

HF=high frequency is an alternating current of a very high number of oscillations (10 kHz to 3000 MHz) and is used in telecommunications engineering.

## **High frequency cables**

Used for conducted transmission of HF signals, e.g. television signals. The quality of the HF cables and lines is characterised by the low reflection, low interference and low attenuation transmission of signals.

## **High frequency power cable**

High frequency power cables are single-core cables with full PE insulation or polystyrol muffs as spacers, outer conductors made of copper wire braid or copper flared tube conductors, and are used as transmission cables for radio transmitters.

## **Hybrid cables**

Consist of at least two different types of cable (e.g. power and audio cables) in a common sleeve.

## **Impedance**

Impedance of the electrical quadripole; it is composed of the ohmic resistance and the reactance, the frequency-dependent resistances and capacitances. Structurally speaking, impedance is specified by the dimensions of the internal conductor, dielectric and shielding.

## **Interference**

Fault, adverse effect, reduction of functionality

## **Indoor cables**

Cable for applications inside buildings. They are not suitable for laying outdoors.

## **Insulation resistance**

This is determined by the insulation material, whereby the material properties are more significant than the insulation thickness. The insulation resistance is dependent on the length. The higher the specific resistance of a material, the more suitable the material is for insulation; the unit is [m]; for cables and wires, the conventional units are the derived units [Mkm] or [Gkm].

## **Interference sensitivity**

Electromagnetic inability of a device, of a unit or of a system to operate without reduction of functionality in the presence of electromagnetic interference.

## **ISDN**

Abbreviation for Integrated Services Digital Network. Integrated digital network for combining different postal services via common digital switches and digital paths, e.g. telephones, data transmission.

## **ISO**

International Standards Organisation: worldwide federation of national standards institutions from more than 130 countries.

## **LAN**

Local Area Network: spatially limited system for high speed information transfer between a limited number of independent terminals with equal rights.

## **LASER**

Light Amplification by Stimulated Emission of Radiation: Amplifier for electromagnetic waves in the visible light spectrum.

## **Lay-length**

The lay-length is the length on which a stranding element is laid, 360 degrees around the stranding axis.

## **LED**

Light Emitting Diode – Light emitting diodes are components that generate light.

## **LON**

Local Operating Network: open bus system which enables components from different manufacturers to interact with one another.

## **Loop resistance**

Total ohmic resistance of transmit and return conductors (unit: W/km)

## **LSOH**

Low smoke and halogen-free (LS = low smoke) and (OH= zero halogen).

## **Microbending**

Bending of a fibre which produces light losses and thus an increase in attenuation.

## **Modem**

Name for a modulator-demodulator. A modem modulates and demodulates analogue and digital electrical voltages. When transmitting data via a modem, the digital electrical signal (a consequence of voltage changes) is converted into an analogue electrical signal (a consequence of amplitude oscillations).

## **Modes**

All waveguides capable of propagation in a fibre optic cable.

## **Modulation cable**

For television transmission from a central or junction point to television transmitters.

## **Network**

System with the associated transfer method that is supported by message coding cabling.

## **OLM**

Optical Link Module: bus component for the construction of fibre optics networks and the transition from copper conductors to fibre optic cable.

## **Outdoor cable**

Cables which are constructed so that they are sufficient for all requirements such as those which occur for underground and pipeline cable systems.

## **Patch cable**

Flexible connecting cable for connecting two components, e.g. in a distributor cabinet.

## **PIMF**

Pair in metal foil.

## **Plug connection**

Easily removable connection with plugs. The insertion loss of a plug connection is usually higher than the transfer loss of a splice connection.

## **POF**

Polymer Optical Fibre - name for a fibre optic cable whose optical core and sheath are constructed using plastic. POF fibres have a typical core diameter of 0.98 mm.

# GLOSSARY

## **Polyethylene (PE)**

A macromolecular hydrocarbon with a paraffin-like structure. Thanks to its outstanding dielectric properties, e.g. low density, high durability and elongation at break, very good electrical insulating properties, low water absorption and the fact that it is practically insoluble in almost all organic solvents, it is now indispensable as an insulating material in the cable industry.

## **Polypropylene (PP)**

Polypropylene is made by means of polymerisation and is classified as a partially crystalline thermoplastic (in a similar way to polyethylene) but has high rigidity, hardness and strength with good electrical properties.

## **Polyurethane (PUR)**

Thermoplastic polyurethanes are similar to polyamides in terms of their properties; however, they absorb hardly any water when compared with these, have outstanding physical properties, are impact-resistant, notch-resistant, have a high degree of flexibility at low temperatures and possess good friction resistance.

## **Polyvinyl chloride (PVC)**

Polyvinyl chloride is a thermoplastic which is manufactured for the cable industry according to the suspension polymerisation process (PVC-S). It is an odourless, free-flowing white powder. It is free of electrolytes and therefore exhibits very good dielectric properties.

## **PROFIBUS**

The Process Field Bus is a field bus with a 3-layered design and a fully developed network management system.

## **PROFIBUS DP**

Profibus for the field of "distributed peripherals". Simple digital and analogue input/output components and intelligent signal and process data processing units can be relocated locally and thus, among other things, significantly reduce costs in terms of the amount of time and effort spent on cabling.

## **ProfiSafe**

Safety profile: allows the transfer of safety-integrated and standard data on a single bus line.

## **Reduction factor**

The thicknesses of the cable sheath (metal sheath, armouring and cable sheath) are increased if telecom cables are located in the vicinity of power cables or railway facilities and electromagnetic fields arise, which result in inductive influence on the operation.

## **Redundancy**

Abundance, excess, surplus

## **Reflection**

Reflection of rays (waves) at border surfaces between two different substances.

## **Repeater**

Repeater, amplifier - apparatus for amplifying and regenerating signals and a network. It can cover larger distances. Simple, economic means of extending a LAN. Repeaters with more than two ports are called hubs.

## **Resistance difference**

Difference of the ohmic resistance between two cores of a cable (unit  $W$ ).

## **RG/U**

Abbreviation of Radio Government, Universal. RG is a military designation for coaxial cables in MIL-C-17. R=Radio, G=Guide, U=Utility.

## **RG58**

Coaxial cable with 50 Ohm wave resistance. Also called Thin Wire or 10BASE2.

## **RJ45**

Connector for twisted pair.

## **Return loss**

Measure for matching systems; when the correct termination resistance of a cable (wave resistance) is selected, the reflection factor is 0 and thus also the return loss.

## **SC**

Straight Connector. Connector.

## **Secondary cabling**

Internal building connection of the building distributor with the individual floor distributors (backbone).

## **Sensor**

Apparatus which converts a physical factor based on a physical effect into an electric, pneumatic or hydraulic signal for further processing. These sensors are used in automation technology to obtain the necessary information for process execution. This includes, for example, the recording of power unit and machine statuses, or the recording of process data such as temperature, pressure, speed, filling level, flow rate, paths, angles, etc.

## **Shield**

Shielding which should prevent the transfer of interference signals, e.g. those from electrical fields for data cables. Usually braided with aluminium or copper. Shields can be arranged for cables and wires by individual elements in the cable or group, or by the entire stranded bundle. The structure of the shield is always determined by how the product is intended to be used. Their purpose is usually to keep external electrical influences away from cables and wires and to prevent these fields from escaping (coupling resistance). Shielding can be made of braids, braiding, metal foils, foil-cladding or steel armouring.

## **Shielding attenuation**

Measure of the reduction or attenuation of the electromagnetic field strength at a point in the room, caused by inserting an electromagnetic shield between the field source and this point; usually expressed in dB.

## **Skin effect**

The tendency of alternating current to flow on the surface of a conductor as the frequency increases (a reduction in the effective conductor cross-section and thus an increase in the electrical resistance).

## **Slotted core cable**

Cable where the fibres are placed in grooves made in the surface of the central element.

## **Smoke density**

Method of measuring smoke development when burning a cable. When laying cables in buildings, it should be ensured that the level of smoke density is low (typical value: 50%).

## **S/PDIF**

Sony/Philips Digital Interface. For transmission of digital audio signals. Flexible coaxial cable, which is assembled using a Cinch connector.

## **Splice**

A permanent cable connection. For fibre optic cables, for example, this involves fusing two fibres.

## **Star coupler**

Active or passive component which ensures a uniform light output distribution for an equally large number of incoming and outgoing fibres.

## **Star quad**

Strand element which consists of four wires twisted together, and each of the pairs of wires forms a transmission path (trunk).

## **STP**

Shielded Twisted Pair.

## **STQ**

Shielded Twisted Quad.

## **Telecom cables**

These are used for transmitting telephone calls, signals and data, primarily in local networks of telecommunications companies.

## **Tertiary cabling**

Horizontal connection of the floor distributor with the connection units at the work place.

## **Tight buffer**

A fibre which is applied immediately above the protective coating of a plastic sleeve.

## **Time multiplex**

Transfer process where several pieces of information are transferred simultaneously with different wavelengths on one fibre.

## **TP**

Twisted Pair. Data cable.

## GLOSSARY

### **Triaxial Cable**

A 3-conductor cable, built on three axes: this consists of one conductor in the centre, the second conductor concentrically around the first conductor and the third conductor insulated from the first and second, usually by insulation, a braid and an outer sheath.

### **Twin axial cable**

A cable which consists of concentric, mutually insulated conductors.

### **Wave bands or frequency ranges**

The frequency ranges used in radio technology are divided into a decade system:

Centimetre waves:	1 - 10 cm
Decimetre waves:	10 - 100 cm
Ultra-short waves:	1 - 10 m
Short waves:	10 - 100 m
Medium waves:	100 - 1000 m
Long waves:	1000 - 10,000 m
Long waves:	10 - 100 km

### **Wavelength**

Length of a complete oscillation (period) of a wave. Three wavelength ranges are usually used in optical message technology. These are around 850 nm, 1310 nm and 1550 nm.

### **Wavelength multiplex**

Transfer process where several parallel incoming data signals are transferred on a fibre in one serial data stream.

### **XLR**

The 5-pin XLR connector is frequently used in professional stage and lighting engineering for transmitting DMX control signals. The XLR connector is also used in professional studio engineering, for microphone cables and speaker cables. The XLR couplings are designated as "female" and the XLR connector plugs are designated as "male".

# ■ ORDER FORM

**To: HELUKABEL® GmbH**  
**Media Technology**  
**Dieselstrasse 8-12**  
**D-71282 Hemmingen**  
**Germany**

Phone +49 7150 9209-0  
 E-mail medientechnik@helukabel.de  
 Fax +49 7150 8884  
 www.helukabel.de

**Sender/stamp**

Ordering party: \_\_\_\_\_  
 Telephone extension: \_\_\_\_\_  
 Order no.: \_\_\_\_\_  
 Customer no. (if available): \_\_\_\_\_

Part no.	Designation	Purchase order quantity	Required packaging method	Price € (net)	Required Delivery date

Our general terms and conditions of delivery and payment apply.

## I would like to know more about HELUKABEL®.

- Please send us your current data, networking and bus technology catalogue
- Please send us your current cables and wires catalogue
- Please send us your current cable accessories catalogue
- We would like to receive regular news about your products
- We have a current requirement and would like to request information about:

---

- I would like to make an appointment with your technical consultant

\_\_\_\_\_ Date

\_\_\_\_\_ Signature





# Part No. Index

<b>Part no.</b>	<b>Page</b>	<b>Part no.</b>	<b>Page</b>	<b>Part no.</b>	<b>Page</b>
10550 – 10615	68	40179	52	400214 – 400235	41
10616 – 10746	69	40180 – 40189	35	400248	33
11464 – 11563	70	40190 – 40196	51	400249 – 400250	34
11574 – 13147	71	40197	48	410000 – 410027	90
13344 – 13367	74	40200 – 40203	50	410028 – 410055	91
13368 – 13489	75	400000 – 400002	16	410056 – 410090	84
13500 – 13530	76	400003 – 400010	17	410091 – 410134	85
13531 – 13597	77	400011	18	410135 – 410147	86
22940 – 22943	78	400012 – 400020	19	410148 – 410171	87
22944 – 22949	79	400021	21	802073 – 802208	88
22989 – 23006	78	400022 – 400024	22	802223 – 802231	89
23007 – 23059	79	400025 – 400029	23		
23104 – 23132	78	400031	25		
23133 – 24000	79	400032 – 400033	26		
26060 – 26119	81	400034	27		
26395 – 26402	80	400036 – 400037	30		
26403 – 26404	81	400038 – 400039	31		
26690 – 26753	80	400040	32		
26755 – 26936	81	400041	33		
29129 – 29192	80	400042 – 400043	20		
29193 – 29933	81	400060	36		
34090 – 34349	73	400061 – 400062	39		
37001 – 37028	72	400068 – 400072	45		
37029 – 37154	73	400073 – 400078	46		
40001 – 40006	47	400080	32		
40007 – 40010	48	400081	28		
40011 – 40012	49	400089 – 400094	36		
40015 – 40018	55	400109 – 400115	37		
40019 – 40021	56	400116 – 400122	38		
40022	44	400143 – 400146	40		
40023 – 40027	35	400151	29		
40028 – 40073	44	400158	23		
40085	55	400168	49		
40135 – 40144	52	400171 – 400174	24		
40145 – 40147	57	400182	55		
40150 – 40169	53	400189	48		
40170 – 40175	44	400190	49		
40176 – 40178	54	400197	55		







## NOTES

### Technical modifications

© HELUKABEL® GmbH Hemmingen

Specifications have been carefully checked and are believed to be correct; however, no responsibility is assumed for inaccuracies. Subject to technical modifications. Consequently all illustrations, numerical data, etc. are provided without guarantee. Color deviations between photos and delivered goods cannot be avoided. Reproduction or duplication of the text and illustrations, in whole or in part, remain reserved. The transfer of copyrights always requires the written consent of HELUKABEL® GmbH. Our General Terms of Delivery and Payment, which can be viewed at [www.helukabel-group.com](http://www.helukabel-group.com), apply.

### Length markings

The length marking, which cannot be calibrated, is an aid, e.g. for easy material allowance determination or for determination of the length remaining on the drum. Deviation of the line length shown by the marking is up to 1%. Incomplete length markings or length markings missing on sections, deviations of the cable length shown by the length marking do not substantiate any legal obligation whatsoever. Only use calibrated measurement devices to determine line length.

### Safety notice

The cables and wires described in the catalog are produced in accordance with national and international standards, as well as plant standards; application safety, as stipulated in the safety directives, standards, and statutory regulations, as amended, is provided. With the prerequisite of proper and professional installation and use, the possibility of product-specific dangers can be excluded. For each product this catalog describes general information for use. Independent of the above, the applicable DIN VDE specifications apply. However, installation and processing must only be executed by qualified electricians.

**Our General Terms of Delivery and Payment, which can be viewed at [www.helukabel-group.com](http://www.helukabel-group.com), apply**

